

IBDN Fiber Connectivity Solutions

Reliable, Scalable, End-to-End
Networking Solutions



**Be certain.
Belden.**

Our End-to-End Expertise.
Your End-to-End Solution.



BELDEN
SENDING ALL THE RIGHT SIGNALS

Belden has the end-to-end fiber cabling system to meet your current networking challenges while providing the bandwidth and scalability for the needs of the future.

**Be certain.
Belden.**

Our End-to-End Expertise.
Your End-to-End Solution.



IBDN Fiber Connectivity Solutions

Belden Fiber Systems Provide Reliable, End-to-End Networking Performance

Belden understands that cabling is the core foundation of every network – its ability to provide high performance, reliable transmission is essential for carrying out day-to-day business operations. From critical data center links that connect network switches and servers, to horizontal and backbone links that deliver voice, data and video for a wide range of networking, communications, audio-visual, security and building management applications, Belden has the end-to-end fiber cabling system to meet your current networking challenges while providing the bandwidth and scalability for the needs of the future.



FiberExpress® Systems

The System that
Reduce Complexity and
Increase Flexibility.



Reduce Complexity and Increase Flexibility

Involvement in the development of optical fiber components for over 40 years, Belden is a leading supplier of high-quality, cost-effective optical fiber cabling systems. The FiberExpress (FX) Systems are the culmination of Belden's experience and expertise in a variety of applications, including data centers, premise and campus network backbone infrastructures, fiber-to-the-desk (FTTD) applications, and horizontal and centralized cabling systems. Guaranteed to meet or exceed all applicable TIA/EIA, ISO/IEC and IEEE standards, each end-to-end FX System is designed to offer reduced complexity, increased flexibility, and rapid installation.

LEED Point documents are available on several products, see specific product pages for LEED document retrieval instructions.



Our End-to-End Expertise.
Your End-to-End Solution.



Table of Contents

IBDN Fiber Connectivity Solutions	Page
Markets	6
Applications	7
A Complete Approach to Fiber Optic Cabling	8–9
■ FiberExpress® Systems	
FiberExpress® System	12
FX® UHD & FX®@EASE Systems	13
FiberExpress®@EASE Patch Panel Systems	14–19
FiberExpress® Patch Panel Systems – FX UHD Housings and Shelves	20–21
FiberExpress® Cassettes	22–25
FiberExpress® Frames	26–27
FiberExpress® Enterprise Closet X (ECX)	28–29
■ Fiber Cable Assemblies	
FX@E LSZH Rated Assemblies	32–39
LSZH Patch Cords	32–33
LSZH Pigtail and Patch Cord Configurators	34–35
LSZH Trunk Assemblies	36–37
LSZH Trunk Assemblies Configurators	38–39
FX CMR/CMP Rated Assemblies	40–45
CMR/CMP Patch Cords	40–41
CMR/CMP Patch Cords and Cable Assemblies Configurators	42–43
CMR/CMP Trunk Assemblies	44–45
SFP+ Active Optical Cable/Transceiver	46–47
■ Workstation	
FiberExpress® Workstation Connectivity	50–55
FX Multi Box (M-Box), MDVO Multimedia Outlet Box and Multi-User Outlet Box	50–51
KeyConnect Square Faceplates	52–53
KeyConnect & MDVO Fiber Adapter Modules	54
FX Secure/Keyed LC System	55
FiberExpress® Field Termination	56–57
FX Brilliance Universal Connectors	56
FX Brilliance Universal Installation Kits and Accessories	57
FiberExpress® Fusion Splice-on Connectors	58–59
■ Wall Mount Systems	
FiberExpress® Wall Mount Systems	62–63
FX UHD Wall Mount	62–63
FX Ultra Wall Mount and Accessories	63–63
FiberExpress® In-Build Systems	64–65
In-Build Wall-Box	64–65
■ Optical Fiber Cables	
Belden Optical Fiber Cables	68
Fiber Types	69
Universal Central Loose Tube Cable with Rodent Protection, Single Jacket	70–71
Universal Mini-Breakout	72–73
Belden Warranties and Certification	74–75



We are a leading company serving a multitude of industries with a strong focus on selected markets.

Markets

The use of multiple infrastructures within the enterprise, comprised of components from any number of infrastructure vendors and installers, adds undue complexity to the buying and specifying process, as well as to the updating and management of the infrastructure.

Adding to this complexity is the fact that most infrastructure vendors are unable to provide both high-value legacy cabling solutions for autonomous systems and high-performance IP-based solutions. Unlike any other infrastructure vendor, Belden tackles these problems by taking a universal approach to the enterprise – resolving every signal transmission need with IP- and legacy-based solutions that enable a smooth migration to convergence. Our high-bandwidth, high-density copper connectivity solutions provide solutions for a diverse set of markets including:

Local Area Networks

Full compliment of innovative and highly reliable infrastructure solutions to support all LAN applications from building entrance to desktop.

Data Center

Consultative design of custom infrastructure solutions for optimal turn-up time, agility, reliability and Total Cost of Ownership.

Key Markets

- Data Hosting
- Healthcare
- Education
- Financial
- Government



Our End-to-End Expertise.
Your End-to-End Solution.



Applications



Industry's Most Extensive Enterprise Connectivity Portfolio

Fiber Cable & Connectivity

- Backbone, campus, in-building and Fiber to the Desk
- Quick Deploy Pre-Term Systems
- Industry Leading Low-Loss Connectivity



Infrastructure Solutions

- Racks & Enclosures
- Rack Power Distribution
- Air Flow and Climate Monitoring
- Cable Management Accessories



Copper Cable & Connectivity

- Category systems for LAN and Data Center
- Access Control Cabling
- Building Automation & Control



Data Center Ready Solutions

- Customization & Design services
- Pre-configured and pre-installed Cable Management and Connectivity options



A Complete Approach to Fiber Optic Cabling

Five different levels of Belden IBDN FiberExpress Systems are offered to meet customers' specific needs.

With the IBDN FiberExpress Systems, Belden takes a complete approach to fiber optic cabling. Uniquely positioned to support everything from legacy fiber systems and current backbone and data center fiber links, to future high-speed fiber transmission and long-reach fiber applications, Belden IBDN FiberExpress Systems are available in five different levels to meet specific customer needs. Each FiberExpress System is available with a wide range of components including:

- Pre-Terminated and Field-Terminated Systems
- Field-installable connectors
- Ultra high-density and standard patch panels and fiber management systems
- Patch cords, pigtails and pre-terminated multi-fiber cable assemblies
- Modular faceplates, modules and adapters
- Customizable hybrid cables, assemblies and housings
- Indoor and outdoor tight buffer and loose-tube distribution and trunk cables
- Interlock armor, direct burial and ruggedized cables for industrial environments



Our End-to-End Expertise.
Your End-to-End Solution.



Belden FX Systems are available in a variety of performance levels to meet the value and price point for a wide variety of applications. Each system is uniquely color-coded for easy identification in the field.

The following is a recap of the five Belden FX Systems that are offered today:

Belden System	FX OM1	FX OM2	FX OM3	FX OM4	FX SM A1
Standard	OM1 - 62.5 µm Multimode Non-Bend Insensitive TIA-492AAAA ANSI/TIA-568-D.3 ISO/IEC 11801	OM2 - 50 µm Multimode Bend Insensitive TIA-492AAAB ANSI/TIA-568-D.3 ISO/IEC 11801	OM3 - 50 µm Multimode Bend Insensitive TIA-492AAAC ANSI/TIA-568-D.3 ISO/IEC 11801	OM4 - 50 µm Multimode Bend Insensitive TIA-492AAD ANSI/TIA-568-D.3 ISO/IEC 11801	OS2 - 9 µm Singlemode Bend Insensitive TIA-492CAAB ANSI/TIA-568-D.3 ISO/IEC 11801 ITU G.657.A1
Ethernet Applications	Legacy 1G up to 275 m	Not Recommended for New Designs	1G up to 550 m 10G up to 300m 40G/100G up to 100m	10G up to 400 m 40G/100G up to 150 m	10G up to 30/40 km 40G/100G up to 10/40 km
Fibre Channel Applications	Legacy 1G up to 300 m	Not Recommended for New Designs	4G up to 380 m 8G up to 300 m 16G up to 100 m	16G up to 125 m	4/8/16G up to 10 km
Fiber Cable Assemblies Jacket Color	Orange	Orange	Aqua	Erika Violet Aqua (optional)*	Yellow
Connector and Adaptor Color	Beige	Black	Aqua	Erika Violet Aqua (optional)*	Blue Green (APC)
Pre-Term Connector Loss	MPO-12 0.5 dB LC/SC/ST 0.25dB	MPO-12 0.5 dB LC/SC/ST 0.25dB	MPO-12 0.35 dB LC/SC/ST 0.25dB	MPO-12 0.2 dB LC/SC/ST 0.15dB	MPO-12 0.75 dB LC/SC/ST 0.35dB
Fiber Cable Loss	Tight Buffer (900 µm) 3.5 dB @ 850 nm 1.2 dB @ 1300 nm Enterprise Loose Tube (250 µm) 3.5 dB @ 850 nm 1.2 dB @ 1300nm	Tight Buffer (900 µm) 3.5 dB @ 850 nm 1.2 dB @ 1300 nm Enterprise Loose Tube (250 µm) 3.5 dB @ 850 nm 1.2 dB @ 1300nm	Tight Buffer (900 µm) 3.25 dB @ 850 nm 1.2 dB @ 1300 nm Enterprise Loose Tube (250 µm) 3.25 dB @ 850 nm 1.0 dB @ 1300nm	Tight Buffer (900 µm) 3.0 dB @ 850 nm 1.0 dB @ 1300 nm Enterprise Loose Tube (250 µm) 3.0 dB @ 850 nm 1.0 dB @ 1300nm	Tight Buffer (900 µm) 0.5 dB @ 1310nm 0.5 dB @ 1550 nm Enterprise Loose Tube (250 µm) 0.5 dB @ 1310nm 0.5 dB @ 1550 nm
Min. EMB (MHz-km)	N/A	N/A	2000 @ 850 nm	4700 @ 850 nm	N/A
Min. OFL Bandwidth (MHz-km)	200 @ 850 nm 500 @ 1300 nm	500 @ 850 nm 500 @1300 nm	1500 @ 850 nm 500 @1300 nm	3500 @ 850 nm 500 @1300 nm	N/A

* Belden Standard OM4 products use Erika Violet cable with Erika Violet connectors. Aqua OM4 cable and connectors are available as Tailored products by selecting OM4 fiber with the Aqua color code. Other combinations of fiber type and color will continue to use the default connector colors with the specified cable jacket color.



Our End-to-End Expertise.
Your End-to-End Solution.



FiberExpress® Systems

Section Table of Contents

■ FiberExpress® Systems	
FiberExpress® System	12
FX® UHD & FX®@EASE Systems	13
FiberExpress®@EASE Patch Panel Systems	14–19
FiberExpress® Patch Panel Systems – FX UHD Housings and Shelves	20–21
FiberExpress® Cassettes	22–25
FiberExpress® Frames	26–27
FiberExpress® Enterprise Closet X (ECX)	28–29

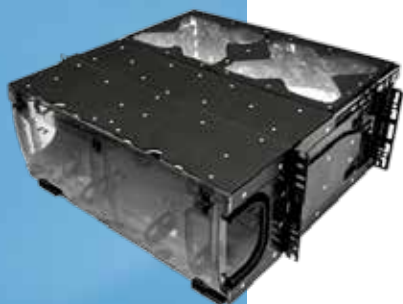



FiberExpress[®] System

Rack-Mount Fiber Connectivity System

The elegantly simple solution for incorporating flexibility, manageability and scalability into high-density fiber channels.

Faster

- Faster field-termination with sliding, tilting drawers
- Faster pre-term installation with fixed shelves and cassettes
- Faster MACs with fewer components

Easier

- Easier installation with tool-less removable drawers and lighter weight
- Easier port identification with clear visible labeling
- Easier configuration with LC, SC, ST and MPO modules

Better

- Better fiber protection with covered patch cord tray
- Better density with up to 72 LC Duplex ports per 1U
- Better visibility with Titanium finish options



With the same look and feel, the cost effective FX UHD Shelf and the feature-rich FX UHD Housing can be mixed and matched to create unique Half Pre-Term systems that provide field termination benefits like exact cable length, the ability to fit in smaller conduits, and rapid cost-effective installation of pre-term solutions.

Termination Type	Feature-Rich FX UHD Housing	Entry-Level FX UHD Shelf
Pre-Term Assemblies		
MPO Trunks	✓	✓
Jacketed Fan-Out	✓	✓
900 μm Fan-Out	✓	X
Field Termination		
Pig-Tail w/Splicing	✓	X
900 μm Connectorization (ie. FX Brilliance)	✓	X
Jacketed Connectorization	✓	✓

Our End-to-End Expertise.
Your End-to-End Solution.



FX[®] UHD & FX[®]@EASE Systems

- Easy configuration for a variety of applications with LC, SC, ST and MPO modules and better density with up to 72 LC Duplex or MPO ports per 1U
- Faster installation with lighter weight, tool-less removable drawers and overall fewer components
- Superior access, fiber protection and port identification with sliding, tilting drawers, covered patch cord tray and clear visible labeling

With support for both legacy ST and SC and modern LC and MPO applications, the FX UHD offers cost effective migration from current 1G and 10G to 40G and 100G applications with only a simple cassette or adapter frame change – and it includes all the installation and management features needed to maintain maximum uptime.

The FX UHD System provides superior port access and protection with up to double the density of comparable units for a 50% space reduction. The intuitive, modular design of the system also means fewer components and a single system to support a variety of port counts and configurations.

Applications

Ideal for fast, reliable, low-cost installations with maximum efficiency, capacity and uptime, the FX UHD System is designed for rapid deployment of high-density fiber interconnects and cross connects at active equipment in data centers, SAN environments and LANs.

Whether in a top of rack, end of row or centralized environment, the system's modular design accommodates high-performance, low-loss fiber architectures with superior flexibility and reconfigurable components to support current 1G and 10G applications and easy migration to future 40G and 100G applications. Using low-loss pre-terminated cassettes and assemblies with the FX UHD System also supports the use of zone distribution areas (ZDAs) that enable pre-cabling the core switch to the row and then rapid deployment down the row as more capacity is needed.

The system's reduced physical footprint offers additional mounting options in both Data Centers and LANs – in shallow racks and cabinets, vertical mounting configurations, and even floor and ceiling boxes. Using Belden KeyConnect frames with modular inserts, the FX UHD System makes it possible to combine fiber, copper and multimedia connectivity in mixed media environments – all in the same rack unit of space.

The ultra high-density rack-mount fiber connectivity system from Belden[®] that offers an elegantly simple solution for incorporating flexibility, manageability and scalability into high-density fiber channels.

The FX UHD System includes a wide range of pre-terminated cassettes and field-terminated frames to support virtually any high-density fiber connectivity need while offering cost effective migration from current 10G to 40 and 100G applications.

Features

- Support for both pre-term installation and field termination
- Better density with up to 72 LC Duplex or MPO ports per 1U
- Adaptable for present and future needs with LC, SC, ST and MPO modules
- 1U, 2U, and 4U configurations and 19" and 23" rack mount options
- Superior cable management and port access with sliding, tilting drawers
- Efficient one-person installation with tool-less removable drawers and lighter weight (4U FX UHD weighs just 2.4 kg)
- Titanium finish option for better visibility, reduced lighting needs and contrast against white cabinets
- Sleek front faceplate for easy shelf identification and clear visible labeling for easy port identification
- Better fiber protection with covered patch cord tray

FiberExpress®@EASE Patch Panel Systems

Solutions for Quicker and Easier Future Proof Fiber Management through Intelligent Readiness

The new FiberExpress@EASE panel is designed and manufactured high quality you expect from Belden with space saving technology to offer improved installation times and a faster Return on Investment (RoI) via:

- Simple 1u footprint
- Easier in-rack management
- Pre-loaded adapters ready for installation
- Splice tray including

FO Panels:

- 48-port termination/splice panel set (with 24x duplex LC or SC in OS2, OM3 or OM4, including splicing cassette and pigtail set)
- 48-port MPO panel set (with 24x duplex LC or SC in OS2, OM3 or OM4, including MPO/LC or MPO/SC assembly set)

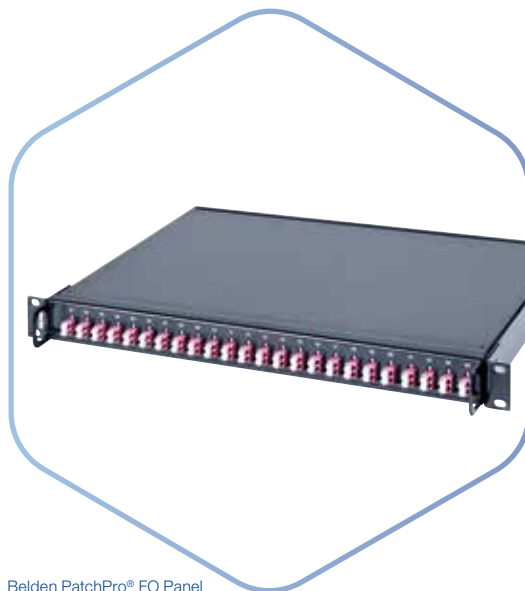

Belden PatchPro® FO Panel

Our End-to-End Expertise.
Your End-to-End Solution.

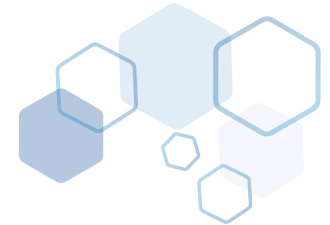

FiberExpress@EASE Panels

Fiber Connectivity MPO Patch Panels	Part Number
PatchPro 48-port LC/UPC-DX OS2 iPLM Ready MPO Panel Set	PPLSMPOR
PatchPro 48-port SC/UPC-DX OS2 iPLM Ready MPO Panel Set	PPSSMPOR
PatchPro 48-port LC/APC-DX OS2 iPLM Ready MPO Panel Set	PPLAMPOR
PatchPro 48-port SC/APC-DX OS2 iPLM Ready MPO Panel Set	PPSAMPOR
PatchPro 48-port LC OM3 iPLM Ready MPO Panel Set	PPL3MPOR
PatchPro 48-port SC OM3 iPLM Ready MPO Panel Set	PPS3MPOR
PatchPro 48-port LC OM4 iPLM Ready MPO Panel Set	PPL4MPOR
PatchPro 48-port SC OM4 iPLM Ready MPO Panel Set	PPS4MPOR
PatchPro 48-port LC/UPC-DX OS2 iPLM Ready MPO alternate Panel Set	PPLSMPOR-ALT
PatchPro 48-port SC/UPC-DX OS2 iPLM Ready MPO alternate Panel Set	PPSSMPOR-ALT
PatchPro 48-port LC/APC-DX OS2 iPLM Ready MPO alternate Panel Set	PPLAMPOR-ALT
PatchPro 48-port SC/APC-DX OS2 iPLM Ready MPO alternate Panel Set	PPSAMPOR-ALT
PatchPro 48-port LC OM3 iPLM Ready MPO alternate Panel Set	PPL3MPOR-ALT
PatchPro 48-port SC OM3 iPLM Ready MPO alternate Panel Set	PPS3MPOR-ALT
PatchPro 48-port LC OM4 iPLM Ready MPO alternate Panel Set	PPL4MPOR-ALT
PatchPro 48-port SC OM4 iPLM Ready MPO alternate Panel Set	PPS4MPOR-ALT

Fiber Connectivity Term/Splice Patch Panels	Part Number
PatchPro 48-port LC/UPC-DX OS2 iPLM Ready Term/Splice Panel Set	PPLSTSR
PatchPro 48-port SC/UPC-DX OS2 iPLM Ready Term/Splice Panel Set	PPSSTSR
PatchPro 48-port LC/APC-DX OS2 iPLM Ready Term/Splice Panel Set	PPLATSR
PatchPro 48-port SC/APC-DX OS2 iPLM Ready Term/Splice Panel Set	PPSATSR
PatchPro 48-port LC OM3 iPLM Ready Term/Splice Panel Set	PPL3TSR
PatchPro 48-port SC OM3 iPLM Ready Term/Splice Panel Set	PPS3TSR
PatchPro 48-port LC OM4 iPLM Ready Term/Splice Panel Set	PPL4TSR
PatchPro 48-port SC OM4 iPLM Ready Term/Splice Panel Set	PPS4TSR

Includes all Connectivity, without RFID & Hardware
Add -H for half loaded panels after the part number(half loaded panels will come with 24 pigtailed)



FiberExpress®@EASE Patch Panel Systems

Fiber Solutions for Even Faster Performance

In today's information-intensive world, optical fiber networks are increasingly being used to support mission-critical data transmissions in financial and government institutions, large enterprises, educational and healthcare facilities across the globe.

Belden fiber solutions meet or exceed all applicable TIA/EIA, ISO/IEC and IEEE standards and offer:

- High bandwidth and transmission speed
- The potential for network growth
- Extended reach – distance
- Fault tolerance
- Greater data security
- Support for Gigabit and multi-Gigabit protocols and networked applications
- Reduced design complexities
- Quick installation
- Increased flexibility



FE Ease SC
DUPLEX SlideoutPanel

Our End-to-End Expertise.
Your End-to-End Solution.



FiberExpress@EASE Panels

Description	Part Number
19" 1U OM2, 24-port, ST Simplex, Term/Splice Panel	NN01406.MM24
19" 1U OM3, 24-port, ST Simplex, Term/Splice Panel	NN01406.3M24
19" 1U OS2, 24-port, ST Simplex, Term/Splice Panel	NN01406.SM24
19" 1U OM2, 24-port, FC Simplex, Term/Splice Panel	NN01407.MM24
19" 1U OM3, 24-port, FC Simplex, Term/Splice Panel	NN01407.3M24
19" 1U OS2, 24-port, FC Simplex, Term/Splice Panel	NN01407.SM24

Configuration for half loaded pigtailed	Part Number
19" 1U OM2, 24-port, ST Simplex, Term/Splice Panel	NN01406.MM12
19" 1U OM3, 24-port, ST Simplex, Term/Splice Panel	NN01406.3M12
19" 1U OS2, 24-port, ST Simplex, Term/Splice Panel	NN01406.SM12
19" 1U OM2, 24-port, FC Simplex, Term/Splice Panel	NN01407.MM12
19" 1U OM3, 24-port, FC Simplex, Term/Splice Panel	NN01407.3M12
19" 1U OS2, 24-port, FC Simplex, Term/Splice Panel	NN01407.SM12





FiberExpress®@EASE Patch Panel Systems

The KeyConnect Patch Panel Series:

- Includes the unique AngleFlex Patch Panel available in 24-port/1U and 48-port/2U configurations. Patent-pending removable angled inserts provide intuitive left, right or bi-directional patch cord routing and more efficient switch connection. Angled inserts eliminate the need for horizontal cable management, for a 27% space savings per rack.
- The Flex Patch Panel series is available in 24-port/1U and 48-port/2U configurations, and is designed to be populated using Category Modular Jacks, Fiber Adapters or Multimedia Modules.

Physical and Mechanical Characteristics

- Multimode LC module: beige and aqua adapters with phosphor bronze sleeve
- Single-mode LC module: blue adapter with ceramic sleeve
- ST Compatible MM/SM: metal adapter with ceramic sleeve
- Materials: Fire-retardant plastic UL94V-0
- Colors: Almond, electrical white and black

Packaging

- KeyConnect Modular Jacks – Individually packaged
- KeyConnect Multimedia Modules – 10 units in a clear plastic bag



10GX AngleFlex
Patch Panel, 1U,
24-port, Black



10GX AngleFlex
Patch Panel, 2U,
48-port, Black

Our End-to-End Expertise.
Your End-to-End Solution.



FiberExpress®EASE Panels

Description	Part Number
AngleFlex Patch Panel, 1U, 24-port, Black	AX103248
AngleFlex Patch Panel, 2U, 48-port, Black	AX103249

Description	Part Number		
	Almond	Electr. White	Black

KeyConnect Multimedia Modules

Multimedia Modules, Copper			
3.5 mm Audio Coupler, F/F, Gold	AX105334-AL	AX105334-EW	AX105334-BK
3.5 mm Audio Coupler, F/Solder, Gold	AX105335-AL	AX105335-EW	AX105335-BK
S-video Coupler, F/F	AX105336-AL	AX105336-EW	AX105336-BK
RCA Gold-plated Coupler, F/F, Red	AX105337-AL	AX105337-EW	AX105337-BK
RCA Gold-plated Coupler, F/F, White	AX105338-AL	AX105338-EW	AX105338-BK
RCA Gold-plated Coupler, F/F, Yellow	AX105339-AL	AX105339-EW	AX105339-BK
RCA Gold-plated Coupler, F/F, Green	AX105340-AL	AX105340-EW	AX105340-BK
RCA Gold-plated Coupler, F/F, Blue	AX105341-AL	AX105341-EW	AX105341-BK
Video F Coax 3GHz, Recess, Gold-Plated	AX105346-AL	AX105346-EW	AX105346-BK
Video F Coax, Recessed	AX102903	AX102904	AX102905
Video F Coax, Flush	AX102906	AX102907	AX102908
Video BNC Coax, Flush	AX104573	AX104575	AX104574
USB 3.0 Coupler, A to A	AX105342-AL	AX105342-EW	AX105342-BK
USB 2.0 Coupler, B to B	AX105344-AL	AX105344-EW	AX105344-BK
HDMI Coupler (Version 1.4)	AX105345-AL	AX105345-EW	AX105345-BK
Multimedia Modules, Fiber			
LC Duplex OM3 (Aqua Adapter)	AX104937	AX104938	AX104939
LC Duplex OM4 (Erika Violet Adapter)	AX105641-AL	AX105641-EW	AX105641-BK
LC Duplex SM (Blue Adapter)	AX102419	AX102420	AX102421
LC Duplex SM/APC (Green Adapter)	AX105642-AL	AX105642-EW	AX105642-BK
SC Duplex OM3 (Aqua Adapter)	AX105643-AL	AX105643-EW	AX105643-BK
SC Duplex SM (Blue Adapter)	AX102686	AX102687	AX102688
SC Duplex SM/APC (Green Adapter)	AX105374-AL	AX105374-EW	AX105374-BK

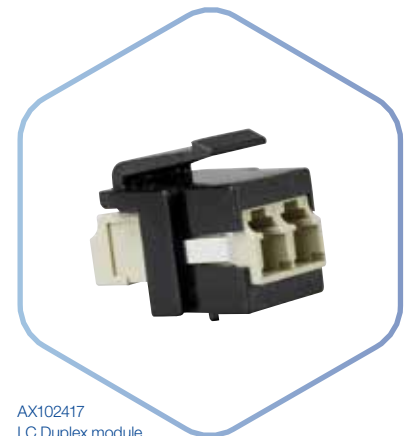

AX102417
LC Duplex module



AX105342-EW
USB 3.0 Coupler
and AX105345-EW HDMI Coupler

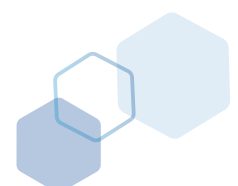

FiberExpress® Patch Panel Systems

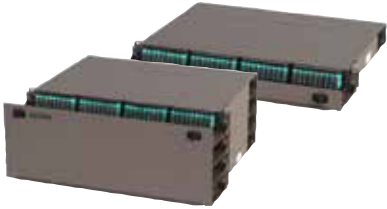

Top: AX104681, FX Ultra HD 1U Patch Panel Housing
Bottom: AX104683, FX UHD 4U Patch Panel Housing (shown loaded)

FX UHD Housings and Shelves

Elegantly simple yet uncompromisingly flexible. Ultra high-density rack-mount fiber connectivity system, crafted for effortless installation and maintenance.

Faster

- Faster field-termination with high-accessibility sliding and tilting drawers
- Faster pre-term installation with simple fixed shelves and cassettes

Easier

- Easier installation with tool-less removable drawers and lightweight housings
- Easier port identification with clear visible labeling
- Easier to configure with flexible port count LC, SC, ST and MPO modules

Better

- Better fiber protection with covered patch cord tray
- Better high density offering with 18-port modules for up to 72 LC Duplex ports per 1U
- Better visibility with light colored Titanium finish



AX104681, FX UHD Patch Panel 1U with Mounted Splice Housing Kit (AX104684)



Top: AX105164, FX UHD 1U Patch Panel Standard Shelf
Bottom: AX105167, FX UHD 4U Patch Panel Recessed Shelf (shown loaded)

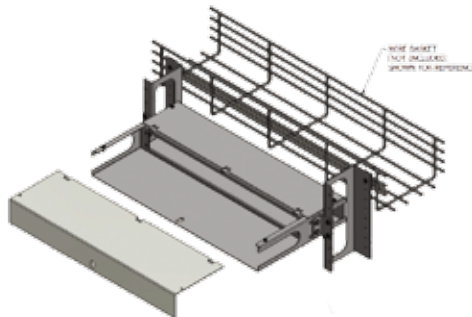

XPE-S0003, FX UHD Basket Hanger for 1U FX UHD Patch Panel Housings and Shelves



AX105700, FX UHD Fiber Management Spool Kit



Left: FXFUBRSHM, FX UHD Single Cassette Holder with Magnetic Attachment
Right: FXFUBRDHM FX UHD Double Cassette Holder with Magnetic Attachment (Bottom)



AX105813 FX UHD 1U Bezel

Use Titanium patch panels to reduce lighting requirements and improve visibility as well as providing sufficient contrast against white cabinets to avoid the snow blind effect.

For rapid expansion within a data center as it grows, Belden Low-Loss Pre-term solutions using the FX UHD System enables ZDA (zone distribution) architectures. ZDA allows pre-cabling the core switch to the row on Day 0 and rapid deployment down the row on Day 1 as capacity is needed.

Optimizes Space in Mixed Media Environments

Belden KeyConnect frames with modular inserts makes it possible to combine fiber, copper and multimedia connectivity – all in the same rack unit of space with in any member of the FX UHD family.

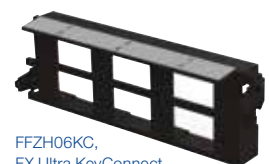

FFZH06KC, FX Ultra KeyConnect Frame, 6-Port

Our End-to-End Expertise.
Your End-to-End Solution.



FX UHD Housings

Feature-rich housings are fully enclosed to provide protection for exposed 250 µm and 900 µm fibers coupled with sliding and tilting drawers to speed up and simplify installation and maintenance.

Description	Number of Module Bays	Total LC Duplex/MPO Ports using FX Ultra Frames and Cassettes	Total LC Duplex/MPO Ports using FX UHD Frames and Cassettes	Belden Part Number
				Titanium
1U Housing with Front and Rear Cable Tray	4	48	72	AX104681
2U Housing with Front and Rear Cable Tray	8	96	144	AX104682
4U Housing with Front and Rear Cable Tray	16	192	288	AX104683
Optional 1U Splice Housing Kit, 144 splices (add up to 4 on the 4U Housing) ¹	N/A	N/A	N/A	AX104684
Optional Patch Cord Tray Cover, 19" ²	N/A	N/A	N/A	AX105162

1. Up to 4 splice housing kits can be added to 4U housings. Splice housing kits are only compatible with standard 19" rack mount housings.
2. Use with 1U or 4U housings to protect the contents of the topmost patch cord tray.

FX UHD Shelves, Single Cassette Holder

Entry-level cost effective solutions for pre-terminated systems.

Description	Number of Module Bays	Total LC Duplex/MPO Ports using FX Ultra Frames and Cassettes	Total LC Duplex/MPO Ports using FX UHD Frames and Cassettes	Belden Part Number	
				Magnetic	Non-Magnetic
1U FX UHD Bezel	4	48	72	AX105813	
1U Standard Fixed Shelf	4	48	72	AX105164	
1U Recessed Fixed Shelf	4	48	72	AX105165	
4U Standard Fixed Shelf	10	120	180	AX105166	
4U Recessed Fixed Shelf	10	120	180	AX105167	
FX UHD Single & Double Cassette Holders				Magnetic	Non-Magnetic
Single Cassette Holder (Black Finish)	1	18	12	FXFUBRSHM	FXFUBRSHM
Double Cassette Holder (Black Finish)	1	36	24	FXFUBRDHM	FXFUBRDHS

Standard FX Ultra KeyConnect Frames

Patch Ports	Description	Belden Part Number
6	FX Ultra KeyConnect Frame 6-Port	FFZH06KC
8	FX Ultra KeyConnect Frame 8-Port	FFZH08KC

Standard FX UHD Accessories

Description	Belden Part Number
FX UHD Blank Plate	FFZH00BB
FX UHD Patch Cord Release Tool	AX104685
FX Ultra LC Duplex Color-coded Icon Kit	AX104572
FX UHD Fiber Management Spool kit, includes base plates and eight spool segments	AX105700
1U Rackmount Enclosure for Cable Tray Mounting	XPE-S0003



FC3H18LDMF, FX UHD Cassette, OS2, 18 Ports, MPO-12 (female), LC Duplex, Type-A, Blue Adapters



FC3U12LDMF1A, FX Ultra Cassette, OM3, 12 Ports, MPO-12 (female), LC Duplex, Type-A ALT, Aqua Adapters



FC3H12LDFS, FX UHD Splice Cassette, OM3, 12 Ports, LC duplex, Aqua Adapters



FCZH00BBFS, FX UHD Empty Splice Cassette

FiberExpress® Cassettes

FX UHD and FX Ultra Cassettes

Featuring the highest density at 72 LC Duplex or MPO ports per 19" rack unit FX UHD family is the ideal choice for high-port count applications such as in the data center.

Unique 1" pull-out feature of the FX Ultra family provides a medium density solution with a superior ease of use for day-to-day MAC (moves, adds and changes) within the Enterprise or cross-connect within the data center.



Pair a Type-A and Type-A ALT on Type-B MPO Trunk to ensure correct port number and to provide simple upgrade path to SR4 (40G/100G) protocols.



Use manageable density FX Ultra modules in dynamic patching environments where ease of access and use and speed are critical. Use FX UHD modules in static patching environments where density is the critical factor.



Use Angled cassettes for MoR or EoR (Middle or End of Row) when combining with Belden AngleFlex copper patch panels to achieve a clean uniform appearance.



FX UHD Angled Cassettes, 12 Ports, LC Duplex and 6 Ports, SC Duplex. See Tailored *SmartPart* numbers for Details.

Tailored FX UHD and FX Ultra Cassettes (Base12)

Building a SmartPart Number

Fixed Letter Series	1. Choose Fiber Type	2. Choose Product Family	3. Choose Port Count (Patch Side)	4. Choose Connector (Patch Side)	5. Choose Connector (Trunk Side)	6. Choose Polarity (Trunk)	7. Choose Adapter Color
FC	3	U	03	LD	MM	A	A
	Fiber Type	Product Family	Port Count (Patch Side)	Connector (Patch Side)	Connector (Trunk Side)	Polarity (Trunk)	Adapter Color
	1 OM1	H FX UHD	03	LD LC Duplex	MM MPO-12 (m)	A Type-A	T Beige
	3 OM3	U FX Ultra (1" Pull)	06	LA LC/APC Duplex	MF MPO-12 (f)	1 Type-A ALT	N Black
	4 OM4	L FX U Angled Left	12	SD SC Duplex			A Aqua
	S OS2	R FX U Angled Right	18	SC SC Simplex			E Erika V.
				SA SC/APC Duplex			B Blue
				SB SC/APC Simplex			G Green
				ST ST			

For further options contact Belden for custom Engineered solutions.

Our End-to-End Expertise.
Your End-to-End Solution.



Standard Type-A Cassettes (Base12)

Description			Belden Part Number				
Patch Ports (fibers)	Trunk Ports	Family	OM1 Beige Adapters	OM3 Aqua Adapters	OM4 Erika Violet Adapters	OS2 Blue Adapters	OS2/APC Green Adapters
LC Duplex to MPO-12(12f) Female							
18 (36)	3	FX UHD*	–	FC3H18LDMF	FC4H18LDMF	FCSH18LDMF	FCSH18LAMF
12 (24)	2	FX Ultra	FC1U12LDMF	FC3U12LDMF	FC4U12LDMF	FCSU12LDMF	FCSU12LAMF
SC Duplex to MPO-12(12f) Female							
6 (12)	1	FX Ultra	FC1U06SDMF	FC3U06SDMF	FC4U06SDMF	FCSU06SDMF	FCSU06SAMF
SC Simplex to MPO-12(12f) Female							
12 (12)	1	FX Ultra	–	–	–	FCSU12SCMF	FCSU12SBMF

*Optional HD Patch cord release tool AX104685

Standard Type-A-Alternate Cassettes (Base12)

Description			Belden Part Number				
Patch Ports (fibers)	Trunk Ports	Family	OM1 Beige Adapters	OM3 Aqua Adapters	OM4 Erika Violet Adapters	OS2 Blue Adapters	OS2/APC Green Adapters
LC Duplex to MPO-12(12f) Female							
18 (36)	3	FX UHD	–	FC3H18LDMF1A	FC4H18LDMF1E	FCSH18LDMF1B	FCSH18LAMF1G
12 (24)	2	FX Ultra	FC1U12LDMF1T	FC3U12LDMF1A	FC4U12LDMF1E	FCSU12LDMF1B	FCSU12LAMF1G
SC Duplex to MPO-12(12f) Female							
6 (12)	1	FX Ultra	FC1U06SDMF1T	FC3U06SDMF1A	FC4U06SDMF1E	FCSU06SDMF1B	FCSU06SAMF1G
SC Simplex to MPO-12(12f) Female							
12 (12)	1	FX Ultra	–	–	–	FCSU12SCMF1B	FCSU12SBMF1G

Standard Splice Cassettes

Description		Belden Part Number				
Patch Ports (fibers)		OM1 Beige Adapters	OM3 Aqua Adapters	OM4 Erika Violet Adapters	SM Blue Adapters	OS2/APC Green Adapters
MPO Type-A (Key-Up/Key-Down)						
12 (144)		FC1H12MPFS	FC3H12MPFS	FC4H12MPFS	–	FCSH12MPFS
LC Duplex						
12 (24)		FC1H12LDFS	FC3H12LDFS	FC4H12LDFS	FCSH12LDFS	FCSH12LAFS
SC Duplex						
6 (12)		FC1H06SDFS	FC3H06SDFS	FC4H06SDFS	FCSH06SDFS	–
SC Simplex						
12 (12)		–	–	–	–	FCSH12SBFS
ST (Metal Adapters)						
12 (12)		FCSH12STFS				
Splice Only (No Adapters)						
N/A (144)		FCZ00BBFS				

FX Brilliance Universal (page 49) or FX Pigtails (page 31 or 39) sold separately.

Standard FX UHD Angled Cassettes (Base12)

Description	Left			Right		
Patch Ports (fibers)	OM3 Aqua Adapters	OM4 Erika Violet Adapters	SM Blue Adapters	OM3 Aqua Adapters	OM4 Erika Violet Adapters	OS2 Blue Adapters
LC Duplex to MPO-12(12f) Female Type-A						
12(24)	FC3L12LDMF	FC4L12LDMF	FCSL12LDMF	FC3R12LDMF	FC4R12LDMF	FCSR12LDMF
LC Duplex to MPO-12 (12f) Female Type-A Alternate						
12(24)	FC3L12LDMF1A	FC4L12LDMF1E	FCSL12LDMF1B	FC3R12LDMF1A	FC4R12LDMF1E	FCSR12LDMF1B
SC Duplex to MPO-12(12f) Female Type-A						
6 (12)	FC3L06SDMF	FC4L06SDMF	FCSL06SDMF	FC3R06SDMF	FC4R06SDMF	FCSR06SDMF
SC Duplex to MPO-12(12f) Female Type-A Alternate						
6 (12)	FC3L06SDMF1A	FC4L06SDMF1E	FCSL06SDMF1B	FC3R06SDMF1A	FC4R06SDMF1E	FCSR06SDMF1B



FiberExpress® Cassettes

Belden FX UHD Base8 Cassettes

Optimized for SR4 and PSM4 based architectures like 40G and 100G Ethernet as well as Compute, Switch and Storage equipment with groupings of 4, 8 and 12 ports. Belden Base8 Cassettes optimize costs when used with Base8 MPO Trunks and Patch cords by eliminating dark fiber associated with SR4 & PSM4 architectures.



FC3U034MMF,
FX UHD Optimizer
Cassette, OM3, Aqua Adapters



FCSU12LD4F,
FX Ultra Cassette,
OM3, 12 Ports, MPO-12 (female), LC Duplex,
Type SR4 (Base8), Aqua Adapters

Tailored FX UHD and FX Ultra Cassettes (Base8)

Building a SmartPart Number

Fixed Letter Series	1. Choose Fiber Type	2. Choose Product Family	3. Choose Port Count (Patch Side)	4. Choose Connector (Patch Side)	5. Choose Connector (Trunk Side)	6. Choose Polarity (Trunk)	7. Choose Adapter Color
FC	3	U	04	LD	4M	4	A
	Fiber Type	Product Family	Port Count (Patch Side)	Connector (Patch Side)	Connector (Trunk Side)	Polarity (Trunk)	Adapter Color
	3 OM3	H FX UHD	04 4 Ports	LD LC Duplex	4M MPO-12 (8f) Male	4 SR4 (Base8)	A Aqua
	4 OM4	U FX Ultra	08 8 Ports		4F MPO-12 (8f) Female		E Erika V.
	S OS2	L FX U Angled Left	12 12 Ports				B Blue
		R FX U Angled Right	16 16 Ports				

For further options contact Belden for custom Engineered solutions.

Our End-to-End Expertise.
Your End-to-End Solution.



Standard SR4 Optimizer Cassettes (Base8)

Description			Belden Part Number		
Patch Ports (fibers)	Trunk Ports	Family	OM3 Aqua Adapters	OM4 Erika Violet Adapters	OS2/APC Green Adapters
MPO-12(8f) Male to MPO-12(12f) Female					
6 x MPO-12 (8f)	4 x MPO-12 (12f)	FX Ultra	FC3U064MMF	FC4U064MMF	FCSU064MMF
3 x MPO-12 (8f)	2 x MPO-12 (12f)	FX Ultra	FC3U034MMF	FC4U034MMF	FCSU034MMF

Standard SR4 Cassettes (Base8)

Description			Belden Part Number		
Patch Ports (fibers)	Trunk Ports	Family	OM3 Aqua Adapters	OM4 Erika Violet Adapters	OS2 Blue Adapters
LC Duplex to MPO-12(8f) Female					
16 (32)	4	FX UHD	FC3H16LD4F	FC4H16LD4F	FCSH16LD4F
12 (24)	3	FX Ultra	FC3U12LD4F	FC4U12LD4F	FCSU12LD4F
8 (16)	2	FX Ultra	FC3U08LD4F	FC4U08LD4F	FCSU08LD4F
4 (8)	1	FX Ultra	FC3U04LD4F	FC4U04LD4F	FCSU04LD4F

Standard SR4 Angled Cassettes (Base8)

Description	Left			Right		
Patch Ports (fibers)	OM3 Aqua Adapters	OM4 Erika Violet Adapters	OS2 Blue Adapters	OM3 Aqua Adapters	OM4 Erika Violet Adapters	OS2 Blue Adapters
LC Duplex to MPO-12(8f) Female						
12 (24)	FC3L12LD4F	FC4L12LD4F	FCSL12LD4F	FC3L12LD4F	FC4L12LD4F	FCSL12LD4F



FiberExpress® Frames

Tailored FX UHD and FX Ultra Frames

Building a SmartPart Number

Fixed Letter Series	1. Choose Fiber Type	2. Choose Product Family	3. Choose Port Count	4. Choose Connector for Patch Side	5. Choose Adapter Color																																	
FF	3	H	18	LD	A																																	
	<table border="1"> <thead> <tr><th>Fiber Type</th></tr> </thead> <tbody> <tr><td>1 OM1</td></tr> <tr><td>3 OM3</td></tr> <tr><td>4 OM4</td></tr> <tr><td>S OS2</td></tr> </tbody> </table>	Fiber Type	1 OM1	3 OM3	4 OM4	S OS2	<table border="1"> <thead> <tr><th>Product Family</th></tr> </thead> <tbody> <tr><td>H FX UHD</td></tr> <tr><td>U FX Ultra (1" Pull)</td></tr> </tbody> </table>	Product Family	H FX UHD	U FX Ultra (1" Pull)	<table border="1"> <thead> <tr><th>Port Count (Patch Side)</th></tr> </thead> <tbody> <tr><td>03</td></tr> <tr><td>06</td></tr> <tr><td>12</td></tr> <tr><td>18</td></tr> </tbody> </table>	Port Count (Patch Side)	03	06	12	18	<table border="1"> <thead> <tr><th>Connector (Patch Side)</th></tr> </thead> <tbody> <tr><td>LD LC Duplex</td></tr> <tr><td>LA LC/APC Duplex</td></tr> <tr><td>LS LC Duplex w/Shutters</td></tr> <tr><td>SD SC Duplex</td></tr> <tr><td>SC SC Simplex</td></tr> <tr><td>SA SC/APC Duplex</td></tr> <tr><td>SB SC/APC Simplex</td></tr> <tr><td>SS SC Duplex w/ Shutters</td></tr> <tr><td>SR SC Simplex w/ Shutters</td></tr> <tr><td>ST ST</td></tr> <tr><td>MP MPO Up/Down</td></tr> <tr><td>MR MPO Up/Up</td></tr> </tbody> </table>	Connector (Patch Side)	LD LC Duplex	LA LC/APC Duplex	LS LC Duplex w/Shutters	SD SC Duplex	SC SC Simplex	SA SC/APC Duplex	SB SC/APC Simplex	SS SC Duplex w/ Shutters	SR SC Simplex w/ Shutters	ST ST	MP MPO Up/Down	MR MPO Up/Up	<table border="1"> <thead> <tr><th>Adapter Color</th></tr> </thead> <tbody> <tr><td>T Beige</td></tr> <tr><td>N Black</td></tr> <tr><td>A Aqua</td></tr> <tr><td>E Erika V.</td></tr> <tr><td>B Blue</td></tr> <tr><td>G Green</td></tr> </tbody> </table>	Adapter Color	T Beige	N Black	A Aqua	E Erika V.	B Blue	G Green
Fiber Type																																						
1 OM1																																						
3 OM3																																						
4 OM4																																						
S OS2																																						
Product Family																																						
H FX UHD																																						
U FX Ultra (1" Pull)																																						
Port Count (Patch Side)																																						
03																																						
06																																						
12																																						
18																																						
Connector (Patch Side)																																						
LD LC Duplex																																						
LA LC/APC Duplex																																						
LS LC Duplex w/Shutters																																						
SD SC Duplex																																						
SC SC Simplex																																						
SA SC/APC Duplex																																						
SB SC/APC Simplex																																						
SS SC Duplex w/ Shutters																																						
SR SC Simplex w/ Shutters																																						
ST ST																																						
MP MPO Up/Down																																						
MR MPO Up/Up																																						
Adapter Color																																						
T Beige																																						
N Black																																						
A Aqua																																						
E Erika V.																																						
B Blue																																						
G Green																																						



FF3H18LD,
FX UHD Frame, OM3,
18 Ports, LC Duplex,
Aqua Adapters

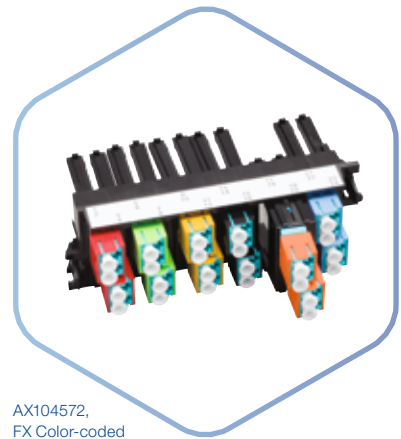

AX104572,
FX Color-coded
Icon Kit, (shown on frame)

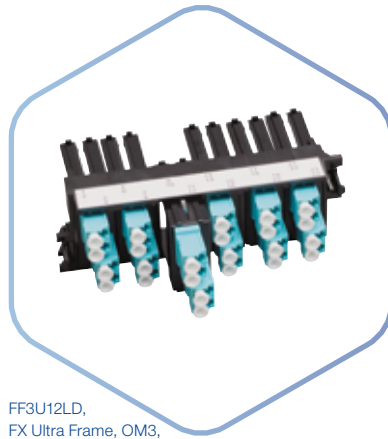

FF3U12LD,
FX Ultra Frame, OM3,
12 Ports, LC Duplex,
Aqua Adapters

Our End-to-End Expertise.
Your End-to-End Solution.



Standard FX UHD and FX Ultra Frames

Description		Belden Part Number				
Patch Ports (fibers)	Family	OM1 Beige Adapters	OM3 Aqua Adapters	OM4 Erika Violet Adapters	SM Blue Adapters	SM/APC Green Adapters
MPO Type-A (Key-Up/Key-Down)						
18	FX UHD	–	FF3H18MP	FF4H18MP	–	FFSH18MP
12	FX Ultra	–	FF3U12MP	FF4U12MP	–	FFSU12MP
LC Duplex						
18 (36)	FX UHD	–	FF3H18LD	FF4H18LD	FFSH18LD	FFSH18LA
12 (24)	FX Ultra	FF1U12LD	FF3U12LD	FF4U12LD	FFSU12LD	FFSU12LA
SC Duplex						
6 (12)	FX Ultra	FF1U06SD	FF3U06SD	FF4U06SD	FFSU06SD	FFSU06SA
SC Simplex						
12 (12)	FX Ultra	–	–	–	FFSU12SC	FFSU12SB
ST						
12 (12), Metal	FX Ultra	← FFSU12ST →				–

KeyConnect Fiber Modules

Description	Belden Part Number		
	Almond	Elec. White	Black
LC Duplex - OM3 (Aqua Adapter)	AX104937	AX104938	AX104939
LC Duplex - OM4 (Erika Violet Adapter)	AX105641-AL	AX105641-EW	AX105641-BK
SC Simplex OM1 (Beige Adapter)	AX102683	AX102684	AX102685
SC Simplex - OM3 (Aqua Adapter)	AX105643-AL	AX105643-EW	AX105643-BK
ST- Metal	AX102242	AX102243	AX102244

COMING
SOON

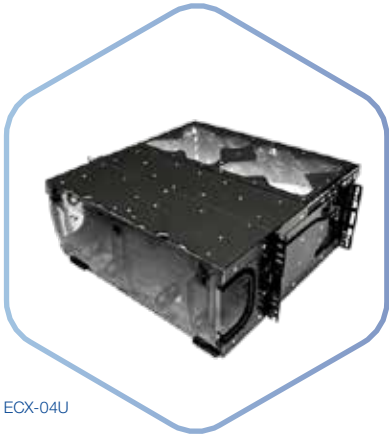

ECX-04U

FiberExpress® Enterprise Closet X (ECX)

Improving on Best-in-Class!

Belden's new FiberExpress (FX) Enterprise Closet X (ECX) Patch Panel system is an elegant, intuitive and flexible solution that has been designed to maximize installer flexibility when compared to industry-leading solutions. FX ECX has been optimized for LAN environments, and provides an easy-to-deploy, efficient solution for installers.

Benefits

- **Maximum installer flexibility for frequent MAC work:** Front and rear removable cassettes (patent pending) on all housings (1U, 2U, 4U). Multiple options for cable strain relief.
- **Simplified installation with fewer detachable components:** Cassette rails molded into housing. No need for extra rail components that can get lost.
- **Reduce space and cost:** ECX accepts mixed-media copper/fiber using KeyConnect frames. Leverage our broad line of KeyConnect copper connectivity products.
- **Eliminate cassette pinch points:** ECX Splice Cassettes integrate slack management into the cassette lid. This simplifies fiber routing and eliminates pinch points.



Features

- Up to 192 LC Duplex ports (384 fibers) in 4U housing
- Tool-less, removable, clear doors and top covers
- Clear top cover for better light and visibility
- Removable front and rear housing (4U)
- Complete family of cassettes and frames
 - LC, SC, ST and MPO adapters available
- Supports all modern field-termination techniques
 - Pigtailed with splice trays
 - Splice cassettes
 - Splice-on connectors (FX Fusion)
 - Mechanical splice connectors (FX Brilliance Universal)



Our End-to-End Expertise.
Your End-to-End Solution.



Ordering Information

FX ECX Housings

Description	Max Capacity	Belden Part Number
1U Housing	2 Cassettes or Frames	ECX-01U
2U Housing	4 Cassettes or Frames	ECX-02U
4U Housing	12 Cassettes or Frames	ECX-04U

Kits/Accessories

Description	Belden Part Number
3 Inch Bracket Mount (4U)	ECX-BRKTMT-3
Flush Bracket Mount (4U)	ECX-BRKTMT-0
Lock Kit (1U/2U/4U)	ECX-LOCKKIT

Additional resources available, see belden.com/ecx for more information.

Splice Cassettes

Description	Belden Part Number			
	OM3 Aqua Adapters	OM4 Erika Violet Adapters	OS2 Blue Adapters	OS2 APC Green Adapters
LC Duplex				
12 (24)	FC3X12LDFS	FC4X12LDFS	FCSX12LDFS	FCSX12LAFS
SC Duplex				
12 (24)	FC3X12SDFS	FC4X12SDFS	FCSX12SDFS	FCSX12SAFS

Please see table below for more adapter/port count options!

To use the configuration matrices, make a selection from each category and combine to form a custom part number. See examples below.

FX ECX Splice Cassette Options

Part number example from configuration shown below:

FCSX06SCFS

FC	S	X	06	SC	FS				
Fiber Type	Family	Port Count (Patch Side)	Connector (Patch Side)	Connector (Trunk Side)					
1	OM1	X	ECX	03	3 ports	LD	LC Duplex	FS	Splice Cassette
3	OM3			06	6 ports	LA	LC Duplex APC		
4	OM4			08	8 ports	SD	SC Duplex		
S	OS2			12	12 ports	SC	SC Simplex		
						SA	SC Duplex APC		
						SB	SC Simplex APC		
						ST	ST		

FX ECX Frames/Adapter Strips

Description	Belden Part Number			
Patch Ports (fibers)	OM3 Aqua Adapters	OM4 Erika Violet Adapters	OS2 Blue Adapters	OS2 APC Green Adapters
LC Duplex				
12 (24)	FF3X12LD	FF4X12LD	FFSX12LD	FFSX12LA
SC Duplex				
12 (24)	FF3X12SD	FF4X12SD	FFSX12SD	FFSX12SA

Please see table below for more adapter/port count options!

FX ECX Frame Options

Part number example from configuration shown below:

FFSX06SC

FF	S	X	06	SC			
Fiber Type	Family	Port Count (Patch Side)	Connector (Patch Side)				
1	OM1	X	ECX	03	3 ports	LD	LC Duplex
3	OM3			06	6 ports	LA	LC Duplex APC
4	OM4			08	8 ports	SD	SC Duplex
S	OS2			12	12 ports	SC	SC Simplex
				16	16 ports	SA	SC Duplex APC
						SB	SC Simplex APC
						ST	ST



Time	Destination	Gate	Status
23:19	HAMBURG	100-481	A
23:19	BILLORE	101-481	B
23:19	BOLENTERRA	102-481	B
23:19	BOLENTERRA	103-481	B
23:19	BOLENTERRA	104-481	B
23:19	BOLENTERRA	105-481	B
23:19	BOLENTERRA	106-481	B
23:19	BOLENTERRA	107-481	B
23:19	BOLENTERRA	108-481	B
23:19	BOLENTERRA	109-481	B
23:19	BOLENTERRA	110-481	B
23:19	BOLENTERRA	111-481	B
23:19	BOLENTERRA	112-481	B
23:19	BOLENTERRA	113-481	B
23:19	BOLENTERRA	114-481	B
23:19	BOLENTERRA	115-481	B
23:19	BOLENTERRA	116-481	B
23:19	BOLENTERRA	117-481	B
23:19	BOLENTERRA	118-481	B
23:19	BOLENTERRA	119-481	B
23:19	BOLENTERRA	120-481	B
23:19	BOLENTERRA	121-481	B
23:19	BOLENTERRA	122-481	B
23:19	BOLENTERRA	123-481	B
23:19	BOLENTERRA	124-481	B
23:19	BOLENTERRA	125-481	B
23:19	BOLENTERRA	126-481	B
23:19	BOLENTERRA	127-481	B
23:19	BOLENTERRA	128-481	B
23:19	BOLENTERRA	129-481	B
23:19	BOLENTERRA	130-481	B
23:19	BOLENTERRA	131-481	B
23:19	BOLENTERRA	132-481	B
23:19	BOLENTERRA	133-481	B
23:19	BOLENTERRA	134-481	B
23:19	BOLENTERRA	135-481	B
23:19	BOLENTERRA	136-481	B
23:19	BOLENTERRA	137-481	B
23:19	BOLENTERRA	138-481	B
23:19	BOLENTERRA	139-481	B
23:19	BOLENTERRA	140-481	B
23:19	BOLENTERRA	141-481	B
23:19	BOLENTERRA	142-481	B
23:19	BOLENTERRA	143-481	B
23:19	BOLENTERRA	144-481	B
23:19	BOLENTERRA	145-481	B
23:19	BOLENTERRA	146-481	B
23:19	BOLENTERRA	147-481	B
23:19	BOLENTERRA	148-481	B
23:19	BOLENTERRA	149-481	B
23:19	BOLENTERRA	150-481	B
23:19	BOLENTERRA	151-481	B
23:19	BOLENTERRA	152-481	B
23:19	BOLENTERRA	153-481	B
23:19	BOLENTERRA	154-481	B
23:19	BOLENTERRA	155-481	B
23:19	BOLENTERRA	156-481	B
23:19	BOLENTERRA	157-481	B
23:19	BOLENTERRA	158-481	B
23:19	BOLENTERRA	159-481	B
23:19	BOLENTERRA	160-481	B
23:19	BOLENTERRA	161-481	B
23:19	BOLENTERRA	162-481	B
23:19	BOLENTERRA	163-481	B
23:19	BOLENTERRA	164-481	B
23:19	BOLENTERRA	165-481	B
23:19	BOLENTERRA	166-481	B
23:19	BOLENTERRA	167-481	B
23:19	BOLENTERRA	168-481	B
23:19	BOLENTERRA	169-481	B
23:19	BOLENTERRA	170-481	B
23:19	BOLENTERRA	171-481	B
23:19	BOLENTERRA	172-481	B
23:19	BOLENTERRA	173-481	B
23:19	BOLENTERRA	174-481	B
23:19	BOLENTERRA	175-481	B
23:19	BOLENTERRA	176-481	B
23:19	BOLENTERRA	177-481	B
23:19	BOLENTERRA	178-481	B
23:19	BOLENTERRA	179-481	B
23:19	BOLENTERRA	180-481	B
23:19	BOLENTERRA	181-481	B
23:19	BOLENTERRA	182-481	B
23:19	BOLENTERRA	183-481	B
23:19	BOLENTERRA	184-481	B
23:19	BOLENTERRA	185-481	B
23:19	BOLENTERRA	186-481	B
23:19	BOLENTERRA	187-481	B
23:19	BOLENTERRA	188-481	B
23:19	BOLENTERRA	189-481	B
23:19	BOLENTERRA	190-481	B
23:19	BOLENTERRA	191-481	B
23:19	BOLENTERRA	192-481	B
23:19	BOLENTERRA	193-481	B
23:19	BOLENTERRA	194-481	B
23:19	BOLENTERRA	195-481	B
23:19	BOLENTERRA	196-481	B
23:19	BOLENTERRA	197-481	B
23:19	BOLENTERRA	198-481	B
23:19	BOLENTERRA	199-481	B
23:19	BOLENTERRA	200-481	B



Our End-to-End Expertise.
Your End-to-End Solution.



Fiber Cable Assemblies

Section Table of Contents

■ Fiber Cable Assemblies	
FX@E LSZH Rated Assemblies	32-39
LSZH Patch Cords	32-33
LSZH Pigtail and Patch Cord Configurators	34-35
LSZH Trunk Assemblies	36-37
LSZH Trunk Assemblies Configurators	38-39
FX CMR/CMP Rated Assemblies	40-45
CMR/CMP Patch Cords	40-41
CMR/CMP Patch Cords and Cable Assemblies Configurators	42-43
CMR/CMP Trunk Assemblies	44-45
SFP+ Active Optical Cable/Transceiver	46-47

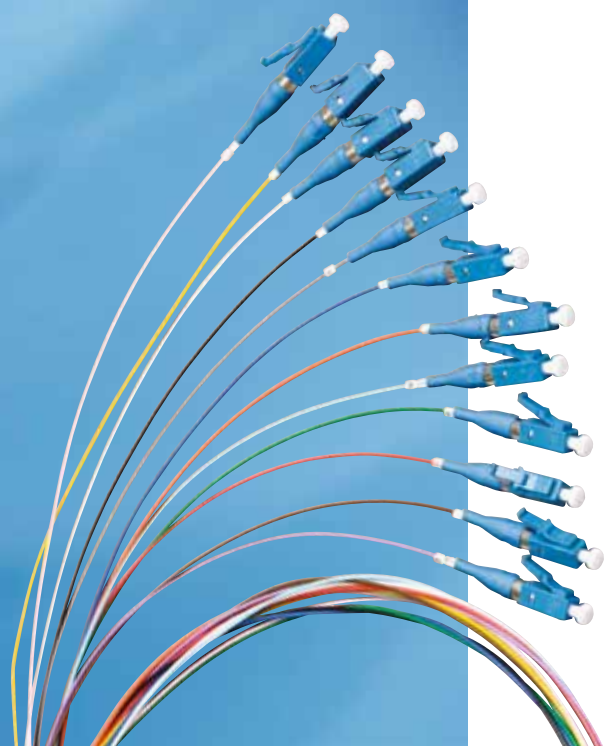

LSZH Patch Cords



FX MPO-12(f) Patch Cords, Assortment



FX LC Duplex Patch Cords, Assortment



FX SC Duplex Patch Cords, Assortment



FX ST Patch Cords, Assortment

FiberExpress Pre-Terminated Assemblies – FX Patch Cords

Uncomplicated, robust, versatile and conveniently available. Superior quality and performance FX patch cords deliver a robust design to withstand the rigours of daily use in both off-the-shelf standard configurations and rapid custom tailored installations.

Faster

- Faster delivery with off-the shelf availability of standard items
- Faster identification of fiber type with Erika Violet for OM4 cables

Easier

- Easier installation in dense cable trays with small diameter cord options
- Easier ordering with simple intelligent *SmartPart* Numbers
- Easier polarity management with industry leading easy-to-use duplex clips

Better

- Better architectural flexibility with low-loss OM4 0.2 dB MPO and 0.15 dB LC connectors
- Better ruggedization with larger diameter cord options
- Better flexibility with multiple connector options including LC, SC, ST and MPO

FX Patch Cords - Standard Performance

Description	FX OM1	FX OM3	FX OM4	FX SM	FX SM/APC
Cable Performance - LC/SC/ST					
IL Max. 850 nm/1300 nm (dB/Km)	3.5/1.2	3.25/1.2	3.0/1.2	-	
IL Max. 1310 nm/1550 nm (dB/Km)	-	-	-	0.5/0.5	
Fire Rating	LC/SC/ST: LSZH				
Cable Style	LC: Interconnect Duplex Zip 2 mm SC/ST/Hybrid: Interconnect Duplex Zip 3 mm				
Connector Performance - LC/SC/ST					
IL Max. (dB)	0.25	0.25	0.15	0.35	0.35
Polish - RL Typ. (dB)	PC - 30	PC - 30	PC - 30	UPC - 55	APC - 65
Polarity	A-T0-B / B-T0-A				
Cable Performance - MPO					
IL Max. 850 nm/1300 nm (dB/Km)	3.5/1.2	3.25/1.0	3.0/1.0	-	
IL Max. 1310 nm/1550 nm (dB/Km)	-	-	-	0.5/0.5	
Fire Rating	LSZH				
Cable Style	MPO-12: Interconnect Mini-Round 2 mm				
Connector Performance - MPO					
IL Max. (dB)	0.5	0.35	0.2	-	0.75
Polish - RL Typ. (dB)	PC - 30	PC - 30	PC - 30	-	APC - 60
Polarity	Type-B				

Our End-to-End Expertise.
Your End-to-End Solution.



FX@E LSZH Patch Cords (Standard)

Length in M	OM1	OM3	OM4	OS2	OS2/APC
LC Duplex to LC Duplex 2mm zipcord					
2m	-	GP-32LDLD002M	GP-42LDLD002M	GP-S2LDLD002M	GP-S2LALA002M
3m	-	GP-32LDLD003M	GP-42LDLD003M	GP-S2LDLD003M	GP-S2LALA003M
5m	-	GP-32LDLD005M	GP-42LDLD005M	GP-S2LDLD005M	GP-S2LALA005M
7m	-	GP-32LDLD007M	GP-42LDLD007M	GP-S2LDLD007M	GP-S2LALA007M
SC Duplex to SC Duplex 2mm zipcord					
2m	GP-12SDSD002M	GP-32SDSD002M	GP-42SDSD002M	GP-S2SDSD002M	GP-S2SASA002M
3m	GP-12SDSD003M	GP-32SDSD003M	GP-42SDSD003M	GP-S2SDSD003M	GP-S2SASA003M
5m	GP-12SDSD005M	GP-32SDSD005M	GP-42SDSD005M	GP-S2SDSD005M	GP-S2SASA005M
7m	GP-12SDSD007M	GP-32SDSD007M	GP-42SDSD007M	GP-S2SDSD007M	GP-S2SASA007M
ST to ST 2mm zipcord					
2m	GP-12STST002M	GP-32STST002M	GP-42STST002M	GP-S2STST002M	-
3m	GP-12STST003M	GP-32STST003M	GP-42STST003M	GP-S2STST003M	-
Hybrid: LC Duplex to SC Duplex 2mm zipcord					
2m	GP-12LDSD002M	GP-32LDSD002M	GP-42LDSD002M	GP-S2LDSD002M	GP-S2LASA002M
3m	GP-12LDSD003M	GP-32LDSD003M	GP-42LDSD003M	GP-S2LDSD003M	GP-S2LASA003M
Hybrid: SC Duplex to ST 2mm zipcord					
2m	GP-12SDST002M	GP-32SDST002M	-	GP-S2SDST002M	-
3m	GP-12SDST003M	GP-32SDST003M	-	GP-S2SDST003M	-

FX@E LSZH MPO Patch Cords (Standard)

Length in M	OM1	OM3	OM4	OS2	OS2/APC
MPO BASE-8 Female to MPO BASE-8 Female					
5m	-	GP-374F4F005M	GP-474F4F005M	-	GP-S74F4F005M
15m	-	GP-374F4F015M	GP-474F4F015M	-	GP-S74F4F015M
30m	-	GP-374F4F030M	GP-474F4F030M	-	GP-S74F4F030M
MPO BASE-12 Female to MPO BASE-12 Female					
5m	-	GP-37MFMF005M	GP-47MFMF005M	-	GP-S7MFMF005M
15m	-	GP-37MFMF015M	GP-47MFMF015M	-	GP-S7MFMF015M
30m	-	GP-37MFMF030M	GP-47MFMF030M	-	GP-S7MFMF030M

FX@E LSZH Hydra Patch Cords (Standard)

Length in M	OM1	OM3	OM4	OS2	OS2/APC
MPO BASE-12 Female to LC Duplex (Fan-out 1.5m x In-line)					
5m	-	GP-37MFLD005MA	GP-47MFLD005MA	-	GP-S7MFLD005MA
15m	-	GP-37MFLD015MA	GP-47MFLD015MA	-	GP-S7MFLD015MA
30m	-	GP-37MFLD030MA	GP-47MFLD030MA	-	GP-S7MFLD030MA
SR4/PSM4: MPO BASE-8 Female to LC Duplex (Fan-out 1.5m x In-line)					
5m	-	GP-374FLD005M4	GP-474FLD005M4	-	GP-S74FLD005M4
15m	-	GP-374FLD015M4	GP-474FLD015M4	-	GP-S74FLD015M4
30m	-	GP-374FLD030M4	GP-474FLD030M4	-	GP-S74FLD030M4

LSZH Pigtail and Patch Cord Configurators

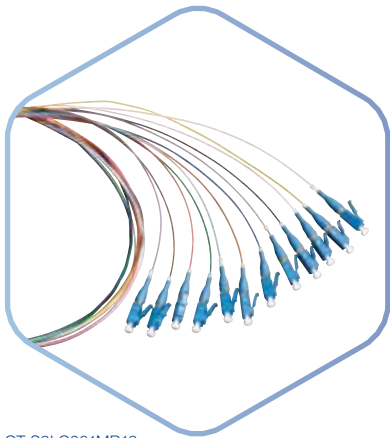

GT-S9LC001MR12,
FX LC Color-coded Pigtail Kit, Singlemode

FX Pigtails

Established technology with a pedigree of resilience. Traditional fusion splice-on connectors with pigtails provide factory-polished performance with field-termination convenience within harsh environments.

Faster

- Faster connector identification with color-coded pigtail kits
- Faster delivery with standard LC, SC or ST 2 meter pigtail kits

Easier

- Easier field-termination with factory pre-terminated connectors
- Easier ordering with intuitive SmartPart numbers

Better

- Better quality with precision factory-polished connectors
- Better insertion loss at 0.2 dB MPO-12 and 0.15 dB Max IL OM4

Standard Performance

Description	FX OM1	FX OM3	FX OM4	FX SM	FX SM/APC
Cable Performance - LC/SC/ST					
IL Max. 850 nm/1300 nm (dB/Km)	3.5/1.2	3.25/1.2	3.0/1.2	-	
IL Max. 1310 nm/1550 nm (dB/Km)	-	-	-	0.5/0.5	
Fire Rating	OFN (<= 3 m) OFNP for Interconnect Ribbon 12-fiber (> 3 m) OFNR for all other cables (> 3 m)				
Cable Style	900 µm Color-coded fiber kit (6 or 12 colors from TIA-598), 900 µm single fiber OM1-Gray, OM3/OM4-Aqua, OS2-White, 250 µm Bare ribbon fiber, Interconnect Simplex/Duplex, 2 mm/3 mm cords, Interconnect Ribbon 12-fiber cable				
Standard Length	2 meters				
Connector Performance - LC/SC/ST					
IL Max. (dB)	0.25	0.25	0.15	0.35	0.35
Polish - RL Typ. (dB)	PC - 30	PC - 30	PC - 30	UPC - 55	APC - 65

Description	FX OM1	FX OM3	FX OM4	FX SM	FX SM/APC
Cable Performance - MPO					
IL Max. 850 nm/1300 nm (dB/Km)	3.5/1.2	3.25/1.0	3.0/1.0	-	
IL Max. 1310 nm/1550 nm (dB/Km)	-	-	-	0.5/0.5	
Fire Rating	OFN (<= 3 m), OFNP (> 3 m)				
Cable Style	250 µm Bare ribbon fiber, Interconnect Ribbon 12-fiber cable, Interconnect Mini-Round 2 mm				
Standard Length	2 meters				
Connector Performance - MPO					
IL Max. (dB)	0.5	0.35	0.2	-	0.75
Polish - RL Typ. (dB)	PC - 30	PC - 30	PC - 30	-	APC - 60

The default fan-out is 0.5 m when there is a transition in a pigtail kit: 900 µm Color-coded fiber kit or 250 µm Bare Ribbon fiber (R06 or R12).

Our End-to-End Expertise.
Your End-to-End Solution.



FX@E LSZH MPO Patch Cords

MPO Patch cords	Fiber	Cable Type	Connector 1	Connector 2	Length in M	Polarity
GP-	3	7	MF	MF	003M	A
	3 OM3	7 3mm Round Cord	4 M MPO Base-8 (M)	4 M MPO Base-8 (M)	005M to 100M *use M as decimal	A Type-A 4 SR4/PSM4 ONLY USED IF APPLICABLE FOR NON-STANDARD
	4 OM4		4 F MPO Base-8 (F)	4 F MPO Base-8 (F)		
	S OS2		M M MPO Base-12 (M)	M M MPO Base-12 (M)		
			M F MPO Base-12 (F)	M F MPO Base-12 (F)		

FX@E LSZH Hydra Patch Cords

Hydra	Fiber	Cable Type	Connector 1	Connector 2	Length in M	Polarity
GP-	3	7	MM	LD	003M	A
	3 OM3	7 3mm Round Cord	4 M MPO Base-8 (M)	L D LC Duplex	005M to 100M *use M as decimal	A Type-A 4 SR4/PSM4 ONLY USED IF APPLICABLE FOR NON-STANDARD
	4 OM4	9 900u	4 F MPO Base-8 (F)	L C LC Simplex		
	S OS2		M M MPO Base-12 (M)	L A LC/APC Duplex		
			M F MPO Base-12 (F)	L B LC/APC Simplex		
				S D SC Duplex		
				S C SC Simplex		
				S A SC/APC Duplex		
				S B SC/APC Simplex		

FX@E LSZH Patch Cords

Patch cords	Fiber	Cable Type	Connector 1	Connector 2	Length in M	Polarity
GP-	3	2	LD	LD	003M	X
	1 OM1	2 2mm Duplex Zip Cord	L D LC Duplex	L D LC Duplex	005M to 100M *use M as decimal	X A/B (Cross) S A/A (Straight) ONLY USED IF APPLICABLE FOR NON-STANDARD
	3 OM3	3 3mm Duplex Zip Cord	L C LC Simplex	L C LC Simplex		
	4 OM4	4 2mm Simplex Cord	L A LC/APC Duplex	L A LC/APC Duplex		
	S OS2	5 3mm Simplex Cord	L B LC/APC Simplex	L B LC/APC Simplex		
			S D SC Duplex	S D SC Duplex		
			S C SC Simplex	S C SC Simplex		
			S A SC/APC Duplex	S A SC/APC Duplex		
			S B SC/APC Simplex	S B SC/APC Simplex		
			F C FC	F C FC		
			F A FC/APC	F A FC/APC		
			S T ST	S T ST		

FX@E LSZH Pigtails

Pigtails	Fiber	Cable Type	Connector	Length in M	Packaging
GT-	3	9	LC	001M	R12
	1 OM1	9 900u	L D LC Duplex	005M to 009M *use M as decimal	S01 Single Pack (for 900u MPO only)
	3 OM3	2 2mm Duplex Zip Cord	L C LC Simplex		B12 12 Pack 900u
	4 OM4	4 2mm Simplex Cord	L A LC/APC Duplex		R12 Rainbow 12 Pack (900u)
	S OS2		L B LC/APC Simplex		S1 Single Pack only for Jacketed pigtails
			S D SC Duplex		
			S C SC Simplex		
			S A SC/APC Duplex		
			S B SC/APC Simplex		
			F C FC		
			F A FC/APC		
			S T ST		
			4 M MPO Base-8 (M)		
			4 F MPO Base-8 (F)		
			M M MPO Base-12 (M)		
			M F MPO Base-12 (F)		
			N M MPO Base-24 (M)		
			N F MPO Base-24 (F)		

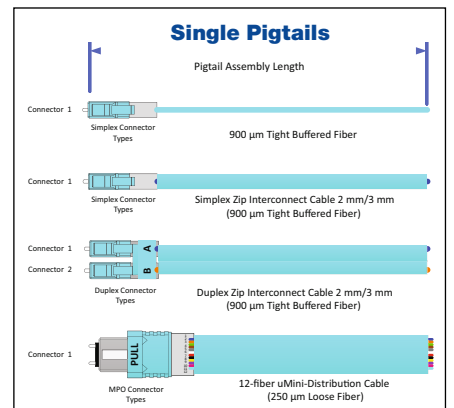
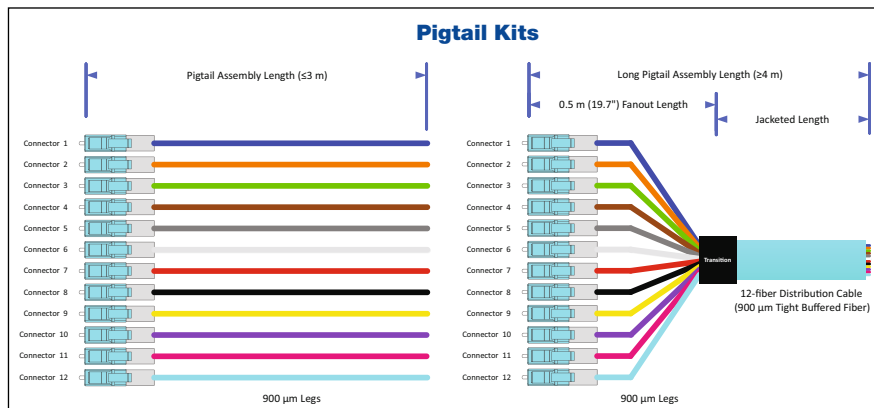

Please contact Belden for any help configuring/validating SmartPart Numbers or for any other custom Engineered solutions

LSZH Trunk Assemblies

FX MPO Trunk Assemblies

Innovative performance with ingrained simplicity. Industry-leading low-loss MPO Trunks are the foundation of Easier, Faster and Better pre-terminated fiber connectivity solutions revolutionizing the data center.

Faster

- Faster identification of fiber type with Erika Violet for OM4 Cable, Connectors and Adapters
- Faster installation with pre-terminated solutions

Easier

- Easier installation with 3-flange reel and default pulling eye
- Easier ordering with simple intelligent *SmartPart* Numbers
- Easier upgradability to 40G and 100G with MPO pre-term solutions

Better

- Better architectural flexibility with high-performance 0.2 dB OM4 MPO connectors
- Better quality through exhaustive design validation against TIA standards
- Better contamination control with Data Center ready packaging



FX MPO Trunk, OM4, MPO-12 (Male to Male), Type-B, 1 x MPO-12 (12 fibers), 10 m, Mini-Distribution 4.8 mm (Double-Jacket), Erika Violet Jacket



FX MPO Trunk, OM3, MPO-12 (Male to Male), Type-B, 1 x MPO-12 (12 fibers), 10 m, Mini-Distribution 4.8 mm (Double-Jacket), Aqua Jacket

FX MPO Trunk Assemblies - Standard Performance

Description	FX OM1	FX OM3	FX OM4	FX SM
Cable Performance				
IL Max. 850 nm/1300 nm (dB/Km)	3.5/1.2	3.25/1.0	3.0/1.0	-
IL Max. 1310 nm/1550 nm (dB/Km)	-	-	-	0.35/0.25
Fire Rating	Plenum			
Cable Style	uMini-Distributon and Mini-Distribution cables			
Connector Performance - MPO-12				
IL Max. (dB)	0.5	0.35	0.2	0.75
Polish - RL Typ. (dB)	PC - 30	PC - 30	PC - 30	APC - 60
Fanout Length	0.5 m, In-Line			
Connector Performance - MPO-24				
IL Max. (dB)	0.5	0.35	0.35	0.75
Polish - RL Typ. (dB)	PC - 30	PC - 30	PC - 30	APC - 60

Our End-to-End Expertise.
Your End-to-End Solution.



FX@E LSZH Multi-fiber Assemblies

Length in M	OM1	OM3	OM4	OS2	OS2/APC
LC Duplex to LC Duplex 2mm zipcord					
10m	-	G-3LLDLD010M	G-4LLDLD010M	G-SLLDLD010M	G-SLLALA010M
15m	-	G-3LLDLD015M	G-4LLDLD015M	G-SLLDLD015M	G-SLLALA015M
20m	-	G-3LLDLD020M	G-4LLDLD020M	G-SLLDLD020M	G-SLLALA020M
30m	-	G-3LLDLD030M	G-4LLDLD030M	G-SLLDLD030M	G-SLLALA030M
SC Duplex to SC Duplex 2mm zipcord					
10m	G-1LSDS010M	G-3LSDS010M	G-4LSDS010M	G-SLSDS010M	G-SLSASA010M
15m	G-1LSDS015M	G-3LSDS015M	G-4LSDS015M	G-SLSDS015M	G-SLSASA015M
20m	G-1LSDS020M	G-3LSDS020M	G-4LSDS020M	G-SLSDS020M	G-SLSASA020M
30m	G-1LSDS030M	G-3LSDS030M	G-4LSDS030M	G-SLSDS030M	G-SLSASA030M
Hybrid: LC Duplex to SC Duplex 2mm zipcord					
10m	G-1LLDSD010M	G-3LLDSD010M	G-4LLDSD010M	G-SLLDSD010M	G-SLLASA010M
15m	G-1LLDSD015M	G-3LLDSD015M	G-4LLDSD015M	G-SLLDSD015M	G-SLLASA015M

FX@E LSZH MPO Trunk Cables

Length in M	OM1	OM3	OM4	OS2	OS2/APC
MPO BASE-8 Female to MPO BASE-8 Female					
10m	-	G-3L4F4F010MB	G-4L4F4F010MB	-	G-SL4F4F010MB
20m	-	G-3L4F4F020MB	G-4L4F4F020MB	-	G-SL4F4F020MB
30m	-	G-3L4F4F030MB	G-4L4F4F030MB	-	G-SL4F4F030MB
MPO BASE-12 Female to MPO BASE-12 Female					
10m	-	G-3LMFMF010MB	G-4LMFMF010MB	-	G-SLMFMF010MB
20m	-	G-3LMFMF020MB	G-4LMFMF020MB	-	G-SLMFMF020MB
30m	-	G-3LMFMF030MB	G-4LMFMF030MB	-	G-SLMFMF030MB

FX@E LSZH Hydra Trunk Cables

Length in M	OM1	OM3	OM4	OS2	OS2/APC
MPO BASE-12 Female to LC Duplex (Fan-out 0.5m x In-line)					
5m	-	G-3LMFLD010MB	G-4LMFLD010MB	-	G-SLMFLA010MB
15m	-	G-3LMFLD020MB	G-4LMFLD020MB	-	G-SLMFLA020MB
30m	-	G-3LMFLD030MB	G-4LMFLD030MB	-	G-SLMFLA030MB
SR4/PSM4: MPO BASE-8 Female to LC Duplex (Fan-out 0.5m x In-line)					
5m	-	G-3L4FLD010MB	G-4L4FLD010MB	-	G-SL4FLA010MB
15m	-	G-3L4FLD020MB	G-4L4FLD020MB	-	G-SL4FLA020MB
30m	-	G-3L4FLD030MB	G-4L4FLD030MB	-	G-SL4FLA030MB

LSZH Trunk Assemblies Configurators

FX Multi-Fiber Cable Assemblies

Superior consistent craftsmanship culminating in near instantaneous installation. Highly configurable multi-fiber pre-terminated cable assemblies are engineering for maximum performance and crafted ensuring superior quality.

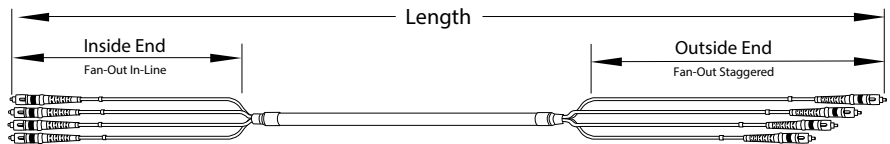

Pulling Eye Diameter

Description	12-Fiber	24-Fiber	36-Fiber	48-Fiber	72-Fiber	96-Fiber	144-Fiber
Installation Diameter - MPO-12 (Total Connectors)	1	2	3	4	6	8	12
1 Connector per Bundle, 8 cm Bundle Stagger		19.5 mm	19.5 mm	19.5 mm	19.5 mm	19.5 mm	19.5 mm
2 Connectors per Bundle, 8 cm Bundle Stagger				25.4 mm	25.4 mm	25.4 mm	25.4 mm
3 Connectors per Bundle, 8 cm Bundle Stagger					30.0 mm	30.0 mm	30.0 mm
4 Connectors per Bundle, 8 cm Bundle Stagger						31.7 mm	31.7 mm
6 Connectors per Bundle, 8 cm Bundle Stagger							38.1 mm
One Bundle, No Stagger (in-line)	19.5 mm	25.4 mm	30.0 mm	31.7 mm	38.1 mm	41.9 mm	50.8 mm

i Standard FX MPO Trunks 12F (Indoor) have a more robust cable construction using a Mini-Distribution cable (Double jacket 4.8 mm). They are designed for safe pulling, and to withstand the rigors of installation while providing sufficient support (wire basket support).

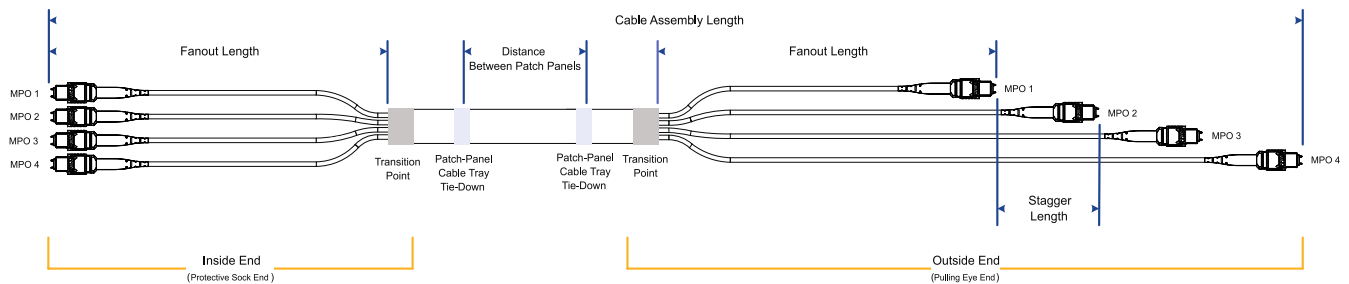

Our End-to-End Expertise.
Your End-to-End Solution.



FX@E LSZH MPO Trunk Cable Assemblies

MPO Trunks	Fiber	Cable Type	Connector 1	Connector 2	Length in M	Polarity	Fiber Count	Fan-Out Geometry
G-	3	L	MF	MF	005M	A	B	1
	3 OM3	L LSZH	4 M MPO Base-8 (M)	4 M MPO Base-8 (M)	005M to 500M	A Type-A	C 24 Fiber	D 0.5m x In-line
	4 OM4	C CPR C Class LSZH	4 F MPO Base-8 (F)	4 F MPO Base-8 (F)		B Type-B	F 48 Fiber	E 1.0m x In-line
	S OS2	I I/O LSZH All Dielectric	M M MPO Base-12 (M)	M M MPO Base-12 (M)		C Type-C	I 72 Fiber	F 1.5m x In-line
		O Outdoor All Dielectric	M F MPO Base-12 (F)	M F MPO Base-12 (F)		4 SR4/PSM4	J 96 Fiber	G 2.0m x In-line
		R Outdoor Armored				K	144 Fiber	1 0.5m x Staggered 80mm - 1 conn. 2 0.5m x Staggered 80mm - 2 conn. 3 0.5m x Staggered 80mm - 3 conn. 4 0.5m x Staggered 80mm - 4 conn. 6 0.5m x Staggered 80mm - 6 conn.
ONLY USED for HIGH FIBER COUNT								

FX@E LSZH Hydra Trunk Cable Assemblies

Hydra Trunks	Fiber	Cable Type	Connector 1	Connector 2	Length in M	Polarity	Fiber Count	Fan-Out Geometry
G-	4	2	MF	LD	005M	4	B	E
	3 OM3	L LSZH	4 M MPO Base-8 (M)	L D LC Duplex	005M to 500M	A Type-A	C 24 Fiber	D 0.5m x In-line
	4 OM4	C CPR C Class LSZH	4 F MPO Base-8 (F)	L C LC Simplex		4 SR4/PSM4	F 48 Fiber	E 1.0m x In-line
	S OS2		M M MPO Base-12 (M)	L A LC/APC Duplex				F 1.5m x In-line
			M F MPO Base-12 (F)	L B LC/APC Simplex				G 2.0m x In-line
				S D SC Duplex				
				S C SC Simplex				
				S A SC/APC Duplex				
				S B SC/APC Simplex				
ONLY USED for HIGH FIBER COUNT								

FX@E LSZH Multi-fiber Trunk Cable Assemblies

Multi-fiber Trunks	Fiber	Cable Type	Connector 1	Connector 2	Length in M	Polarity	Fiber Count	Fan-Out Geometry
G-	S	D	LD	LD	005M	X	A	E
	3 OM3	L LSZH	L D LC Duplex	L D LC Duplex	005M to 500M	X A/B (Cross)	1 1 Fiber	D 0.5m x In-line
	4 OM4	C CPR C Class LSZH	L C LC Simplex	L C LC Simplex		S A/A (Straight)	2 2 Fiber	E 1.0m x In-line
	S OS2	I I/O LSZH All Dielectric	L A LC/APC Duplex	L A LC/APC Duplex			A 12 Fiber	F 1.5m x In-line
		O Outdoor All Dielectric	L B LC/APC Simplex	L B LC/APC Simplex			C 24 Fiber	G 2.0m x In-line
		R Outdoor Armored	S D SC Duplex	S D SC Duplex			F 48 Fiber	
			S C SC Simplex	S C SC Simplex				
			S A SC/APC Duplex	S A SC/APC Duplex				
			S B SC/APC Simplex	S B SC/APC Simplex				
ONLY USED for HIGH FIBER COUNT								



CMR/CMP Patch Cords



FX MPO-12(f) Patch Cords, Assortment



FX LC Duplex Patch Cords, Assortment



FX LC Duplex UHD Uniboot Patch Cords, Assortment



FX SC Duplex Patch Cords, Assortment



FX ST Patch Cords, Assortment

FiberExpress Pre-Terminated Assemblies – FX Patch Cords

Uncomplicated, robust, versatile and conveniently available. Superior quality and performance FX patch cords deliver a robust design to withstand the rigours of daily use in both off-the-shelf standard configurations and rapid custom tailored installations.

Faster

- Faster delivery with off-the shelf availability of standard items
- Faster identification of fiber type with Erika Violet for OM4 cable and connectors

Easier

- Easier installation in dense cable trays with small diameter cord options
- Easier ordering with simple intelligent *SmartPart* Numbers
- Easier polarity management with industry leading easy-to-use duplex clips

Better

- Better architectural flexibility with low-loss OM4 0.2 dB MPO and 0.15 dB LC connectors
- Better ruggedization with larger diameter cord options
- Better flexibility with multiple connector options including LC, SC, ST and MPO
- Better quality through exhaustive design validation against TIA standards

FX Patch Cords - Standard Performance

Description	FX OM1	FX OM3	FX OM4	FX SM	FX SM/APC
Cable Performance - LC/SC/ST					
IL Max. 850 nm/1300 nm (dB/Km)	3.5/1.2	3.25/1.2	3.0/1.2	-	
IL Max. 1310 nm/1550 nm (dB/Km)	-	-	-	0.5/0.5	
Fire Rating	LC/SC/ST: Riser				
Cable Style	LC: Interconnect Duplex Zip 2 mm LC Uniboot: Interconnect Mini-Round 2 mm SC/ST/Hybrid: Interconnect Duplex Zip 3 mm				
Connector Performance - LC/SC/ST					
IL Max. (dB)	0.25	0.25	0.15	0.35	0.35
Polish - RL Typ. (dB)	PC - 30	PC - 30	PC - 30	UPC - 55	APC - 65
Polarity	A-TO-B / B-TO-A				
Cable Performance - MPO					
IL Max. 850 nm/1300 nm (dB/Km)	3.5/1.2	3.25/1.0	3.0/1.0	-	
IL Max. 1310 nm/1550 nm (dB/Km)	-	-	-	0.5/0.5	
Fire Rating	Plenum				
Cable Style	MPO-12: Interconnect Mini-Round 2 mm				
Connector Performance - MPO					
IL Max. (dB)	0.5	0.35	0.2	-	0.75
Polish - RL Typ. (dB)	PC - 30	PC - 30	PC - 30	-	APC - 60
Polarity	Type-B				

Our End-to-End Expertise.
Your End-to-End Solution.



FX Accessory Duplex Clips

Description	Belden Part Number				
	OM1 Beige	OM3 Aqua	OM4 Erika Violet	OS2 Blue	OS2 Green
LC Duplex	FXFACLLDB25T	FXFACLLDB25A	FXFACLLDB25E	FXFACLLDB25B	FXFACLLDB25G
Mini-LC Duplex	FXFACLLMB25N (Black)				

Standard FX Patch Cords

Length (m)	OM1 Beige/Orange	OM3 Aqua	OM4 Erika Violet	OS2 Blue/Yellow	OS2/APC Green/Yellow
MPO-12(8f) Female to MPO-12(8f) Female - Base8					
2	-	FP34F4F002M	FP44F4F002M	-	FPS4F4F002M
3	-	FP34F4F003M	FP44F4F003M	-	FPS4F4F003M
5	-	FP34F4F005M	FP44F4F005M	-	FPS4F4F005M
MPO-12(12f) Female to MPO-12(12f) Female - Base12					
2	-	FP3MFMF002M	FP4MFMF002M	-	FPSMFMF002M
3	-	FP3MFMF003M	FP4MFMF003M	-	FPSMFMF003M
5	-	FP3MFMF005M	FP4MFMF005M	-	FPSMFMF005M
MPO-24 Female to MPO-24 Female					
2	-	FP3NFNF002M	FP4NFNF002M	-	FPSNFNF002M
3	-	FP3NFNF003M	FP4NFNF003M	-	FPSNFNF003M
5	-	FP3NFNF005M	FP4NFNF005M	-	FPSNFNF005M
LC Duplex UHD Uniboot to LC Duplex UHD Uniboot					
2	-	FP3LULU002M	FP4LULU002M	FPSLULU002M	-
3	-	FP3LULU003M	FP4LULU003M	FPSLULU003M	-
5	-	FP3LULU005M	FP4LULU005M	FPSLULU005M	-
LC Duplex to LC Duplex					
2	FP1LDLD002M	FP3LDLD002M	FP4LDLD002M	FPSLDLD002M	FPSLALA002M
3	FP1LDLD003M	FP3LDLD003M	FP4LDLD003M	FPSLDLD003M	FPSLALA003M
5	FP1LDLD005M	FP3LDLD005M	FP4LDLD005M	FPSLDLD005M	FPSLALA005M
SC Duplex to SC Duplex					
2	FP1SDSD002M	FP3SDSD002M	FP4SDSD002M	FPSSDSD002M	FPSSASA002M
3	FP1SDSD003M	FP3SDSD003M	FP4SDSD003M	FPSSDSD003M	FPSSASA003M
5	FP1SDSD005M	FP3SDSD005M	FP4SDSD005M	FPSSDSD005M	FPSSASA005M
ST to ST (Duplex Cord)					
2	FP1STST002M	FP3STST002M	FP4STST002M	FPSSTST002M	-
3	FP1STST003M	FP3STST003M	FP4STST003M	FPSSTST003M	-
5	FP1STST005M	FP3STST005M	FP4STST005M	FPSSTST005M	-
Hybrid: LC Duplex to SC Duplex					
2	FP1LSDSD002M	FP3LSDSD002M	FP4LSDSD002M	FPSLSDSD002M	FPSLASA002M
3	FP1LSDSD003M	FP3LSDSD003M	FP4LSDSD003M	FPSLSDSD003M	FPSLASA003M
5	FP1LSDSD005M	FP3LSDSD005M	FP4LSDSD005M	FPSLSDSD005M	FPSLASA005M
Hybrid: SC Duplex to ST					
2	FP1LDST002M	FP3LDST002M	-	FPSLDST002M	-
3	FP1LDST003M	FP3LDST003M	-	FPSLDST003M	-
5	FP1LDST005M	FP3LDST005M	-	FPSLDST005M	-
LC Simplex UHD to LC Simplex UHD, Simplex cord					
2	-	-	-	FPSLIL002M	FPSLFLF002M
3	-	-	-	FPSLIL003M	FPSLFLF003M
5	-	-	-	FPSLIL005M	FPSLFLF005M





FP4LUMF002M, FX Hydra Patch Cord, OM4, MPO-12F (F) to 6 x LC Duplex UHD Uniboot, 2 m



FP4LDMF002M, FX Hydra Patch Cord, OM4, MPO-12F (F) to 6 x LC Duplex, 2 m



FP3LDMF002M, FX Hydra Patch Cord, OM3, MPO-12F (F) to 6 x LC Duplex, 2 m

CMR/CMP Patch Cords and Cable Assemblies Configurators

FX Hydra Patch Cords

Uniquely suited within dense fixed environments. Compact alternative for statically configured patch cords and pre-term cassettes eliminates connection points to improve performance and alleviate space constraints.

Faster

- Faster deployment at the switch with MPO to LC fanout construction

Easier

- Easier upgradability from 10G to 40G or 100G with MPO connectivity

Better

- Better identification of fiber type with Erika Violet for OM4 cable and connectors
- Better airflow with small transition point construction

FX Hydra Assemblies - Standard Performance

Description	FX OM3	FX OM4	FX SM	FX SM/APC
Cable Performance - LC/SC/ST				
IL Max. 850 nm/1300 nm (dB/Km)	3.25/1.0	3.0/1.0	-	
IL Max. 1310 nm/1550 nm (dB/Km)	-	-	0.5/0.5	
Fire Rating	Plenum			
Cable Style	MPO: Interconnect Mini-Round 3.0 mm LC Uniboot: Interconnect Mini-Round 2.0 mm LC: Interconnect Simplex Zip 2.0 mm			
Connector Performance - LC				
IL Max. (dB)	0.25	0.15	0.35	0.35
Polish - RL Typ. (dB)	PC - 30	PC - 30	UPC - 55	APC - 65
Fanout Length	0.5 m, In-Line			
Connector Performance - MPO				
IL Max. (dB)	0.35	0.2	-	0.75
Polish - RL Typ. (dB)	PC - 30	PC - 30	-	APC - 60
Polarity	Type-A			

See duplex clips on page 18

Standard FX Hydra Assemblies

Description	OM3 Aqua	OM4 Erika Violet	OS2 Blue/Yellow
Base12 Duplex			
MPO-12(12f) Female to 6 x LC Duplex UHD Uniboot, 0.5 m In-Line Fanout, 2 m in length	FP3LUMF002M	FP4LUMF002M	FPSLUMF002M
MPO-12(12f) Female to 6 x LC Duplex UHD Uniboot, 0.5 m In-Line Fanout, 3 m in length	FP3LUMF003M	FP4LUMF003M	FPSLUMF003M
MPO-12(12f) Female to 6 x LC Duplex UHD Uniboot, 0.5 m In-Line Fanout, 5 m in length	FP3LUMF005M	FP4LUMF005M	FPSLUMF005M
Base8 Duplex for SR4 (QSFP+/QSFP28) Transceivers			
MPO-12(8f) Female to 4 x LC Duplex UHD Uniboot, 0.5 m In-Line Fanout, 2 m in length	FP3LU4F002M	FP4LU4F002M	FPSLU4F002M
MPO-12(8f) Female to 4 x LC Duplex UHD Uniboot, 0.5 m In-Line Fanout, 3 m in length	FP3LU4F003M	FP4LU4F003M	FPSLU4F003M
MPO-12(8f) Female to 4 x LC Duplex UHD Uniboot, 0.5 m In-Line Fanout, 5 m in length	FP3LU4F005M	FP4LU4F005M	FPSLU4F005M

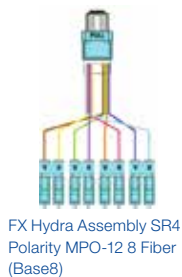

FX Hydra Assembly SR4 Polarity MPO-12 8 Fiber (Base8)

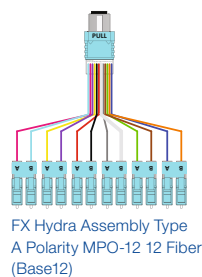

FX Hydra Assembly Type A Polarity MPO-12 12 Fiber (Base12)

Our End-to-End Expertise.
Your End-to-End Solution.



FX CMP/R MPO Patch Cords

MPO cords	Fiber	Connector 1	Connector 2	Length in M	Fire Rating	Cable Type	Polarity
FP	3	MF	MF	005M	R	7	A
	3 OM3	M M MPO Base-12 (M)	M M MPO Base-12 (M)	005M to 100M	R Riser	7 3mm Round Cord	A Type-A
	4 OM4	M F MPO Base-12 (F)	M F MPO Base-12 (F)		P Plenum		4 SR4/PSM4
	S OS2	4 M MPO Base-8 (M)	4 M MPO Base-8 (M)				
		4 F MPO Base-8 (F)	4 F MPO Base-8 (F)				

FX CMP/R Hydra Assemblies

Hydra cords	Fiber	Connector 1	Connector 2	Length in M	Fire Rating	Cable Type	Polarity
FP	3	LD	MM	005M	R	7	A
	1 OM1	L D LC Duplex	M M MPO Base-12 (M)	005M to 100M	R Riser	7 3mm Round Cord	A Type-A
	3 OM3	L C LC Simplex	M F MPO Base-12 (F)		P Plenum		4 SR4/PSM4
	4 OM4	L A LC/APC Duplex	4 M MPO Base-8 (M)				
	S OS2	L B LC/APC Simplex	4 F MPO Base-8 (F)				
		S D SC Duplex					
		S C SC Simplex					
		S A SC/APC Duplex					
		S B SC/APC Simplex					

FX CMP/R Patch Cords

Patch cords	Fiber	Connector 1	Connector 2	Length in M	Fire Rating	Cable Type	Polarity
FP	3	LD	LD	003M	R	2	X
	1 OM1	L D LC Duplex	L D LC Duplex	005M to 100M	R Riser	2 2mm Duplex Zip Cord	X A/B (Cross)
	3 OM3	L C LC Simplex	L C LC Simplex		P Plenum	3 3mm Duplex Zip Cord	S A/A (Straight)
	4 OM4	L A LC/APC Duplex	L A LC/APC Duplex			4 2mm Simplex Cord	
	S OS2	L B LC/APC Simplex	L B LC/APC Simplex			5 3mm Simplex Cord	
		S D SC Duplex	S D SC Duplex				
		S C SC Simplex	S C SC Simplex				
		S A SC/APC Duplex	S A SC/APC Duplex				
		S B SC/APC Simplex	S B SC/APC Simplex				
		F C FC	F C FC				
		F A FC/APC	F A FC/APC				
		S 2 ST2	S 2 ST2				
		S T ST	S T ST				

FX CMP/R Pigtailed

Pigtail cords	Fiber	Connector	Cable type	Product Family	Packaging	Length in M
FT	3	LC	900	P	R12	2M
	1 OM1	L D LC Duplex	250 250u	P Fusion pigtail	S01 Single Pack (for MPO only)	1M to 9M
	3 OM3	L C LC Simplex	900 900u		R12 Rainbow 12 Pack	
	4 OM4	L A LC/APC Duplex	2MM 2mm Simplex Cord			
	S OS2	L B LC/APC Simplex	3MM 3mm Simplex Cord			
		S D SC Duplex				
		S C SC Simplex				
		S A SC/APC Duplex				
		S B SC/APC Simplex				
		F C FC				
		F A FC/APC				
		S T ST				
		M M MPO Base-12 (M)				
		M F MPO Base-12 (F)				

CMR/CMP Trunk Assemblies



FX MPO Trunk, OM4, MPO-12 (Male to Male), Type-B, 1 x MPO-12 (12 fibers), 10 m, Mini-Distribution 4.8 mm (Double-Jacket), Erika Violet Jacket



FX MPO Trunk, OM3, MPO-12 (Male to Male), Type-B, 1 x MPO-12 (12 fibers), 10 m, Mini-Distribution 4.8 mm (Double-Jacket), Aqua Jacket

FX MPO Trunk Assemblies

Innovative performance with ingrained simplicity. Industry-leading low-loss MPO Trunks are the foundation of Easier, Faster and Better pre-terminated fiber connectivity solutions revolutionizing the data center.

Faster

- Faster identification of fiber type with Erika Violet for OM4 Cable, Connectors and Adapters
- Faster installation with pre-terminated solutions

Easier

- Easier installation with 3-flange reel and default pulling eye
- Easier ordering with simple intelligent *SmartPart* Numbers
- Easier upgradability to 40G and 100G with MPO pre-term solutions

Better

- Better architectural flexibility with high-performance 0.2 dB OM4 MPO connectors
- Better quality through exhaustive design validation against TIA standards
- Better contamination control with Data Center ready packaging

FX MPO Trunk Assemblies - Standard Performance

Description	FX OM1	FX OM3	FX OM4	FX SM
Cable Performance				
IL Max. 850 nm/1300 nm (dB/Km)	3.5/1.2	3.25/1.0	3.0/1.0	-
IL Max. 1310 nm/1550 nm (dB/Km)	-	-	-	0.35/0.25
Fire Rating	Plenum			
Cable Style	uMini-Distribution and Mini-Distribution cables			
Connector Performance - MPO-12				
IL Max. (dB)	0.5	0.35	0.2	0.75
Polish - RL Typ. (dB)	PC - 30	PC - 30	PC - 30	APC - 60
Fanout Length	0.5 m, In-Line			
Connector Performance - MPO-24				
IL Max. (dB)	0.5	0.35	0.35	0.75
Polish - RL Typ. (dB)	PC - 30	PC - 30	PC - 30	APC - 60

Our End-to-End Expertise.
Your End-to-End Solution.



Pulling Eye Diameter

Description	12-Fiber	24-Fiber	36-Fiber	48-Fiber	72-Fiber	96-Fiber	144-Fiber
Installation Diameter - MPO-12 (Total Connectors)	1	2	3	4	6	8	12
1 Connector per Bundle, 8 cm Bundle Stagger		19.5 mm	19.5 mm	19.5 mm	19.5 mm	19.5 mm	19.5 mm
2 Connectors per Bundle, 8 cm Bundle Stagger				25.4 mm	25.4 mm	25.4 mm	25.4 mm
3 Connectors per Bundle, 8 cm Bundle Stagger					30.0 mm	30.0 mm	30.0 mm
4 Connectors per Bundle, 8 cm Bundle Stagger						31.7 mm	31.7 mm
6 Connectors per Bundle, 8 cm Bundle Stagger							38.1 mm
One Bundle, No Stagger (in-line)	19.5 mm	25.4 mm	30.0 mm	31.7 mm	38.1 mm	41.9 mm	50.8 mm

i Standard FX MPO Trunks 12F (Indoor) have a more robust cable construction using a Mini-Distribution cable (Double jacket 4.8 mm). They are designed for safe pulling, and to withstand the rigors of installation while providing sufficient support (wire basket support).

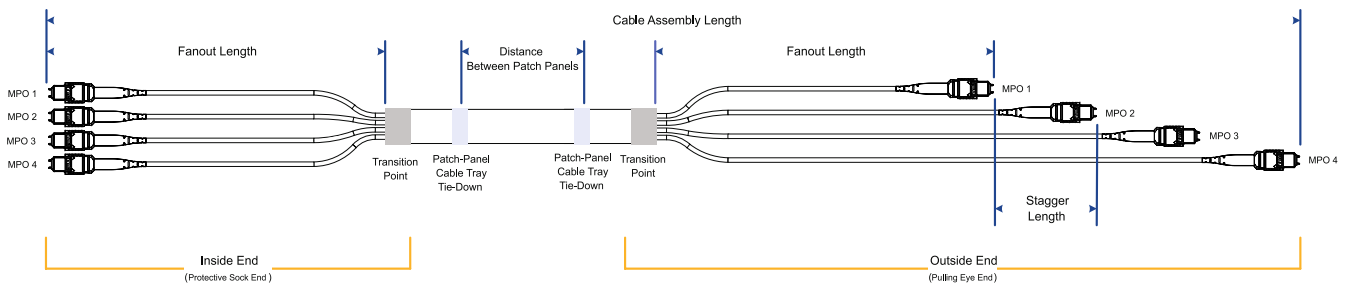

FX CMR MPO Trunk Cables

Length in M	OM1	OM3	OM4	OS2	OS2/APC
MPO BASE-12 Female to MPO BASE-12 Female					
10m	-	FM3MFB1010M	FM4MFB1010M	-	FMSMFB1010M
20m	-	FM3MFB1020M	FM4MFB1020M	-	FMSMFB1020M
30m	-	FM3MFB1030M	FM4MFB1030M	-	FMSMFB1030M
MPO BASE-12 (8f) Female to MPO BASE-12 (8f) Female					
10m	-	FM34FB1010M	FM44FB1010M	-	FMS4FB1010M
20m	-	FM34FB1020M	FM44FB1020M	-	FMS4FB1020M
30m	-	FM34FB1030M	FM44FB1030M	-	FMS4FB1030M

FX CMR/P MPO Trunk Cable Assemblies

MPO Trunks	Fiber	Connector	Gender	Polarity	Fiber Count	Length in M	Fire Rating	Cable Type	Fan-Out Geometry
FM	4	M	F	B	2	005M	P	M	1
	3 OM3	4 MPO Base-8	M Male to Male	A Type-A	1 12 Fiber	005M to 100M	R Riser	Mini-Distribution 3.0mm	D 0.5 m x In-line
	4 OM4	M MPO Base-12	F Female to Female	B Type-B	2 24 Fiber		P Plenum		E 1.0 m x In-line
	S OS2		E Male to Female		3 36 Fiber				F 1.5 m x In-line
			P Male to Open		4 48 Fiber				G 2.0 m x In-line
			R Female to Open		6 72 Fiber				1 0.5 m x Staggered 80 mm - 1 conn.
					8 96 Fiber				2 0.5 m x Staggered 80 mm - 2 conn.
					D 144 Fiber		3 0.5 m x Staggered 80 mm - 3 conn.		
								4 0.5 m x Staggered 80 mm - 4 conn.	
								6 0.5 m x Staggered 80 mm - 6 conn.	



SFP+ Active Optical Cable/ Transceiver

Save money without compromising speed or system performance with Belden's Active Optical Cable (AOC) and Optical Transceiver. Achieve high coupling efficiency of ~60%, high yield and low power consumption with these reliable solutions. A customized connectivity solution using Belden's fiber optic products will provide what you need to drive higher speeds and improve data connectivity while reducing operating costs.



Benefits

- Lower-cost solution when compared to traditional fiber installation
- Works with most major brands of networking equipment
- Lower total cost of ownership



Features

- Low power consumption
< 0.3 W per Transceiver
< 0.6 W for AOC
- Low-cost proprietary light coupling and assembly
- Easy-release pull tabs



Key Applications

- InfiniBand (SDR, DDR, QDR, FDR-10)
- 10G Ethernet
- Fibre channel (10GFC)
- Top-of-rack switching
- Storage area networks

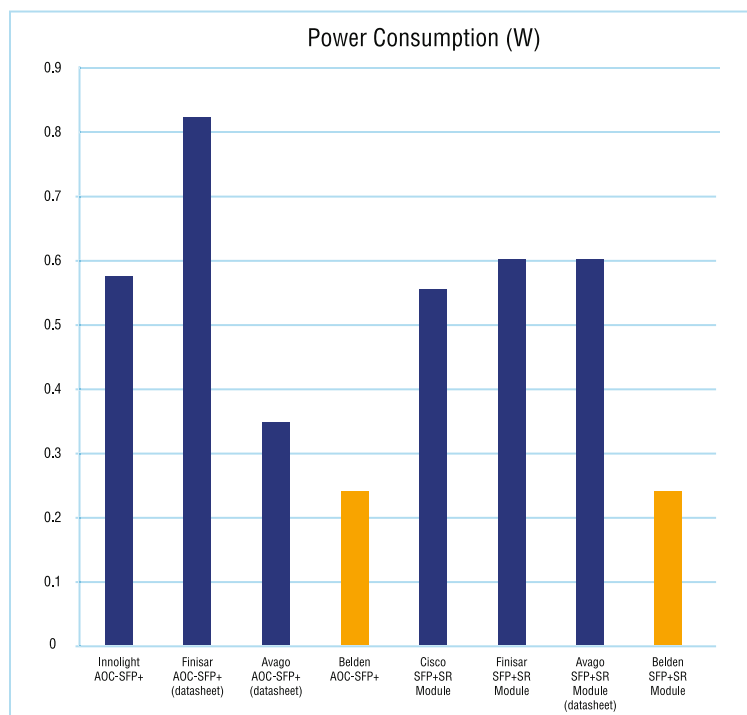

Our End-to-End Expertise.
Your End-to-End Solution.



Ordering Information

To use the configuration matrices, make a selection from each category and combine to form a custom part number. See examples below.

Active Optical Cable

Part number example from configuration shown below:

AS+S+10G001MLSO

A	S+		S+		10		G		001M		L		S		O	
FX AOC	Inside End		Outside End		Performance/ Application		Compatibility		Length & Measure		Flammability		Temperature Range		Jacket Color	
	S+	SFP+	S+	SFP+	10	10G	G	Generic	001M	1 m	L	LSZH	S	Standard (0°C - 70°C)	0	Orange
							1	Cisco	003M	3 m	P	Plenum				
									005M	5 m						
									008M	8 m						
									010M	10 m						
									020M	20 m						
									100M	100 m						
									150M	150 m						

Optical Transceiver

Part number example from configuration shown below:

MS+10G300MS-S1

M		S+		10		G		300M		S		-S1	
FX Module		Inside End		Performance/ Application		Compatibility		Reach		Temperature Range		Unit per Pack	
M	Multimode Module	S+	SFP+	10	10G	G	Generic	300M	300 m	S	Standard (0°C-70°C)	-S1	1 unit pack
						1	Cisco					-B10	10 unit pack
												-B20	20 unit pack



BELDEN

SENDING ALL THE RIGHT SIGNALS



Our End-to-End Expertise.
Your End-to-End Solution.



Workstation

Section Table of Contents

■ Workstation	
FiberExpress® Workstation Connectivity	50–55
FX Multi Box (M-Box), MDVO Multimedia Outlet Box and Multi-User Outlet Box	50–51
KeyConnect Square Faceplates	52–53
KeyConnect & MDVO Fiber Adapter Modules	54
FX Secure/Keyed LC System	55
FiberExpress® Field Termination	56–57
FX Brilliance Universal Connectors	56
FX Brilliance Universal Installation Kits and Accessories	57
FiberExpress® Fusion Splice-on Connectors	58–59





FiberExpress® Workstation Connectivity

FX Multi Box (M-Box) and MDVO Multimedia Outlet Box

Strategically placed connectivity through overt design. Compact low-port count field-term or pre-term distributed consolidation points minimizing installation time by maximizing trunk capacity.

Faster

- Faster installation with a variety of surface mount options

Easier

- Easier distribution of low port count connectivity and breakouts with self-contained designs
- Easier field-termination with easily accessible consolidation points

Better

- Better options for pre-term and field-term including splicing



FWSWBF04SB, FX W-Box, 4 x SC/APC Simplex

FX Wall Box (W-Box)

Protect and manage field-terminated fiber within a compact easily mounted termination box supporting both Mechanical Splice and Fusion Splice termination techniques.

Description	Belden Part Number			
	OM3 Aqua	OM4 Erika Violet	OS2 Blue	OS2/APC Green
FX Wall-Box, 1x SC Simplex	–	–	FWSWBF01SC	FWSWBF01SB
FX Wall-Box, 2x SC Simplex	–	–	FWSWBF02SC	FWSWBF02SB
FX Wall-Box, 4x SC Simplex	–	–	FWSWBF04SC	FWSWBF04SB



FW3MBP06LD, FX M-Box Pre-Term, 6 x LC Duplex, 1 MPO-12(f), OM3

FX Multi Box (M-Box)

Extremely compact, the feature rich M-Box is ideally suited for floor box and consolidation point applications. Supporting pre-terminated MPO-12(f) connectivity with an integrated fanout to LC, 1G and 10G Ethernet can be quickly deployed and re-deployed eliminating field termination. When the need arises additional versions of the M-Box are fully equipped to handle and protect field termination including both mechanical splice and pigtail fusion splicing techniques.

Description	Belden Part Number			
	OM3 Aqua	OM4 Erika Violet	OS2 Blue	OS2/APC Green
FX Multi-Box Pre-Term MPO-12(f) to 6 x LC Duplex	FW3MBP06LD	FW4MBP06LD	FWSMBP06LD	FWSMBP06LA
FX Multi-Box Field-Term, (with Pigtails)	FW3MBS06LD	FW4MBS06LD	FWSMBS06LD	FWSMBS06LA
FX Multi-Box Field-Term, (without Pigtails)	FW3MBF06LD	FW4MBF06LD	FWSMBF06LD	FWSMBF06LA

Our End-to-End Expertise.
Your End-to-End Solution.



MDVO Multimedia Outlet Box

The MDVO Multimedia Outlet Box brings unique versatility for multimedia work area installations. The box design provides cable management and helps maintain cable bend radius. The low profile design and side-entry of the outlet box offers better protection for patch cords. The outlet box can accept up to six MDVO-style modules or three SC Duplex footprint adapters. The MDVO Multimedia Outlet Box can be mounted directly on the wall or attached to standard electrical boxes. Included with the MDVO Multimedia box are three 1-port SC Duplex footprint mounting bezels and three 2-port MDVO adapters.

Description	Belden Part Number	
	Almond	White
MDVO Multimedia Outlet Box, 6-Port	A0643206	A0643207

*See the Belden copper catalog for a larger selection.



0643206,
MDVO Multimedia
Outlet Box (shown terminated)

Multi-User Outlet Box, MDVO Fiber Adapter Modules, KeyConnect Fiber Adapter Modules and Standard Duplex Fiber Adapters

Multi-User Outlet Box

The Multi-User Outlet Box is a versatile box that can be used in many different applications. The outlet box can accommodate up to 24 connections of any type: UTP, fiber or coax. The outlet box is ideal for use as a multi-user telecommunications assembly, or simply as a high-density multimedia telecommunications outlet. The Multi-User Outlet Box can also be used as a wall mounted patch panel in confined areas, such as shallow rooms and cabinets.

Description	Belden Part Number		
	Almond	Elec. White	Black
Multi-User Outlet Box, 24-MDVO Ports (Empty)	AX100220	AX100221	AX100222
Multi-User KeyConnect 12-Port Adapter Strip	-	-	AX104615
Multi-User MDVO 12-Port Adapter Strip	-	-	AX100223



AX100222,
Multi-User Outlet Box
(shown here with optional modules)



FiberExpress® Workstation Connectivity

KeyConnect Square Faceplates

Belden's new faceplate (86x86) range to complete IBDN® workstations quickly and efficiently, with the added benefit of installation flexibility, and uniform aesthetics.

Plenty of Choice for Maximum Flexibility

- The Belden faceplate range offers a choice of five faceplates, and two styles.
- The faceplates are capable of accepting category jacks, fiber adapters and multi-media modules in keystone style.
- These new faceplates can be either wall-mounted on an appropriate wall back box or underfloor mounted in floor faceplates and are available in Electric White color.

Durability and Reliability

- All Belden faceplates are designed to provide maximum durability, protection and reliable performance.
- They feature a sturdy design for impact resistance, made from the best quality ABS.
- They include a shutter to protect modules from dust and debris and provide optimum performance, density and durability, while inserts and adapters are easily released for further configurations.
- Label windows are situated at the top part of the faceplates, so that the cords do not block the labels.
- This facilitates easy identification, avoiding labels at the bottom where they could not easily be seen after installation.

Our End-to-End Expertise.
Your End-to-End Solution.



Description	Part Number
-------------	-------------

KeyConnect Square Faceplates

Premium Two Piece Faceplate/Almond	
KeyConnect Tilted Single Faceplate – Fiber 86 x 86 x 37.7	AX104447F
KeyConnect Tilted Double Faceplate – Fiber 86 x 86 x 37.7	AX104448F

KeyConnect Tamper Resistant Faceplates

Faceplate Kit, KeyConnect-Style/White	
4-port, single-gang with locking cover patch cord seal and wall gasket (dust and water resistant)	AX104687
4-port, single-gang with locking cover (secure outlet)	AX104688
Secure screw driver bit (Drilled Spanner 1/4")	AX104689

Description	Part Number		
	White	Black	Gray

MDVO Faceplates and Inserts

6c Faceplates			
Single Gang, Single Aperture	NN01520	NN01532	NN01544
Single Gang, Dual Aperture	NN01521	NN01533	NN01545
Double Gang, Quad Aperture	NN01522	NN01534	NN01546

6c Inserts			
Shuttered Adapter, 1 Port Flush, KeyConnect	NN01525	NN01537	NN01549
Shuttered Adapter, 1 Port Angled, KeyConnect	NN01526	NN01538	NN01550
Blank Insert, 1 Port	NN01527	NN01539	NN01551

Euromod Faceplates			
Single Gang, 50 x 50 mm Aperture	NN01523	NN01535	NN01547
Double Gang, 50 x 100 mm Aperture	NN01524	NN01536	NN01548

Euromod Inserts			
Shuttered Adapter, 1 Port Flush, KeyConnect	NN01528	NN01540	NN01552
Shuttered Adapter, 1 Port Angled, KeyConnect	NN01529	NN01541	NN01553
Blank Insert, 12.5 x 50 mm	NN01530	NN01542	NN01554
Blank Insert, 25 x 50 mm	NN01531	NN01543	NN01555



AX104448F
KeyConnect
Tilted Double Faceplate



AX104688
KeyConnect
Tamper-Resistant Faceplate
with locking cover



6c Faceplates

FiberExpress® Workstation Connectivity

KeyConnect & MDVO Fiber Adapter Modules



AX102101,
OM4 MDVO
Adapter Module
with LC Keyed Red Adapter, White Holder



AX104939,
KeyConnect Adapter,
LC Duplex, OM3 (Aqua Adapter), Black Holder

MDVO Fiber Adapter Modules

Description	Belden Part Number		
	Almond	Elec. White	Black
LC Duplex - OM3 (Aqua Adapter)	AX105505-AL	AX105505-WH	AX105505-BK
SC Simplex - OM3 (Aqua Adapter)	AX105697-AL	AX105697-WH	AX105697-BK

All MDVO Adapter Modules listed above come in quantities of 25 per package
Please contact Belden for any help configuring/validating *SmartPart* Numbers or for any other custom Engineered solutions

KeyConnect Fiber Adapter Modules

Description	Belden Part Number		
	Almond	Elec. White	Black
LC Duplex - OM3 (Aqua Adapter)	AX104937	AX104938	AX104939
LC Duplex - OM4 (Erika Violet Adapter)	AX105641-AL	AX105641-EW	AX105641-BK
SC Simplex OM1 (Beige Adapter)	AX102683	AX102684	AX102685
SC Simplex - OM3 (Aqua Adapter)	AX105643-AL	AX105643-EW	AX105643-BK
ST- Metal	AX102242	AX102243	AX102244

All KeyConnect Adapter Modules listed above come in quantities of 25 per package
Please contact Belden for any help configuring/validating *SmartPart* Numbers or for any other custom Engineered solutions

Standard Duplex Footprint Fiber Adapters

Description	Belden Part Number			
	OM3 Aqua	OM4 Erika Violet	OS2 Blue	OS2/APC Green
SC Duplex, Flangeless	AX105691-B25	AX105692-B25	AX105002-B25	AX105646-B25
SC Duplex w/Shutters, Flangeless	-	-	AX105693-B25	AX105694-B25

Refer to the Belden copper catalog for a larger selection of workstation connectivity options.

Our End-to-End Expertise.
Your End-to-End Solution.



FiberExpress® Secure/ Keyed LC System

FX Secure/Keyed LC System

The FX Secure/Keyed LC System allows for physical segregation of network segments in secure fiber cabling infrastructures. All Secure/Keyed LC products are available with 12 different keying options each carrying a different color to facilitate network administration. The keying detail inside the connector is highly tamper-resistant and cannot be reproduced inside a standard LC connector to violate the network security. All products comply with the FOCIS 10 standard and optical performance exceeds all industry standards for SFF connectors.

The Secure/Keyed LC Adapter Modules, Frames, Cassettes and Adapter Strips can be used in all mounting hardware for workstation area, Consolidation Point or Telecom Room applications. The Secure/Keyed LC FX Manager Modules can be used in 19- and 23-inch FX Manager Shelves to provide a high-density management system.

The Secure/Keyed LC FX Ultra Frames and Cassettes can be used with the FX UHD Rack and FX Ultra Wall-mount Patch Panels to provide an Ultra high-density patching system that is easy to deploy, operate and maintain, while ensuring maximum uptime, uninterrupted availability and superior performance.

The Secure/Keyed LC Patch Cords and Pigtailed are offered in Multimode 62.5 μm (OM1), laser-optimized 50 μm (OM3 and OM4) and Singlemode (OS2) for the most demanding network performance.

The Secure/Keyed LC Brilliance Universal Field Installable Connectors are available in Multimode 50 μm laser-optimized (OM4, OM3 compatible) and Singlemode (OS2) fiber versions.

FX Secure/Keyed LC System

Description	Splices
LC Key1	Red
LC Key2	Green
LC Key3	Yellow
LC Key4	Black
LC Key5	Orange
LC Key6	Blue
LC Key7	Violet
LC Key8	Rose
LC Key9	Aqua
LC KeyA	Brown
LC KeyB	Slate
LC KeyC	White

For additional details, please refer to the Secure/Keyed LC System Product Bulletin PB275.



FX Secure/
Keyed LC System



FX Brilliance
Connectors



FX Secured/
Keyed LC Ultra Cassette

FiberExpress® Field Termination



FX Brilliance
Universal Connectors

FX Brilliance Universal Connectors

Brilliant in design and universal in implementation, FX Brilliance Universal no-epoxy, no-polish, no-crimp field-installable connectors make fiber field termination faster, easier and better with our industry-leading design.

Faster

- Faster fiber termination in as few as 5 seconds
- Faster installation proficiency through simple termination technique
- Faster 250 µm direct installation eliminating break-out kits

Easier

- Easier with no epoxy or polishing
- Easier no-crimp design
- Easier with duplex clips to hold TX/RX pairs together

Better

- Better termination yield with integrated VFL feedback
- Better universal cable support for 250 µm, 900 µm, 2 mm Jacketed, 3 mm Jacketed
- Better universal fiber support for OM1, OM2, OM3, OM4 as well as OS2

Three Simple Steps

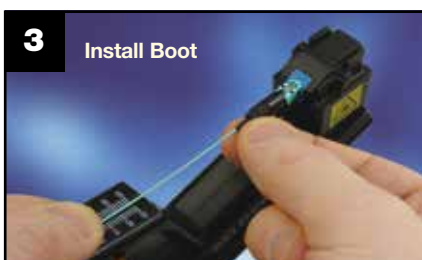

Connector Performance	Maximum Insertion Loss	Typical Insertion Loss	Return Loss
Multimode	0.5 dB	0.2 dB	25 dB
Singlemode UPC	0.5 dB	0.3 dB	50 dB
Singlemode APC	0.5 dB	0.3 dB	60 dB

Description	Belden Part Number		
	Multimode, OM1	Multimode, OM3/OM4 - Aqua	Multimode, OM4 - Erika Violet
LC with 900 µm Boot, 25 per package	AX105200-B25	AX105202-B25	AX105252-B25
SC with 900 µm Boot, 25 per package	AX105205-B25	AX105207-B25	AX105253-B25
ST with 900 µm Boot, 25 per package	AX105210-B25	AX105212-B25	AX105254-B25

Replace -B25 with -S1 for sample 1 per package.

Description	Belden Part Number			
	Singlemode, OS2		Singlemode, OS2/APC	
	1 per package	25 per package	1 per package	25 per package
LC with 900 µm Boot	AX105203-S1	AX105203-B25	-	-
SC with 900 µm Boot	AX105208-S1	AX105208-B25	AX105209-S1	AX105209-B25
ST with 900 µm Boot	AX105213-S1	AX105213-B25	-	-

FX Brilliance Universal includes a boot for 900 µm Tight Buffered fiber. Boots for 2 mm/3 mm Jacketed fiber are sold separately.

Description	Belden Part Number
250 µm Boot, 25 per package	FXBUB0250B25N
2 mm Jacketed Boot, 25 per package	AX105214-B25
3 mm Jacketed Boot, 25 per package	AX105215-B25

Description	Belden Part Number
LC Duplex Clip (Black), 25 per package	FXBUCLLDB25N
SC Duplex Clip (Black), 25 per package	FXBUCLSDB25N

Our End-to-End Expertise.
Your End-to-End Solution.



FX Brilliance Universal Installation Kits and Accessories

Improve Installer Comfort, Repeatability and Performance

Although termination of the FX Brilliance Universal connector can be done with no specialized tools, installation kits are available with all the tools necessary to prepare the fiber as well as to provide a stable work platform to achieve optimal installation results.

FX Brilliance Installation Kit

Description	Belden Part Number
Precision Installation Kit (Basic Kit, Fiber Preparation Tools, Precision Cleaver and Visual Fault Locator)	AX104271

FX Brilliance Accessories

Description	Belden Part Number
Precision Cleaver	AX104286
Precision Cleaver Replacement Blade (for FC-7 cleaver)	AX104293
Precision Cleaver Replacement Blade (for FC-7R cleaver)	AX104593
Support Handle with Adapters	AX104276
Support Handle LC Adapter	AX104289
Support Handle SC Adapter	AX104290
Support Handle ST Adapter	AX104291
Visual Fault Locator (VFL-250) with Adapter Cords	AX104283
Visual Fault Locator (VFL-125) LC-LC Adapter Cord	AX203567
Visual Fault Locator (VFL-125/250) LC-SC Adapter Cord (valid for ST also)	AX203568
Visual Fault Locator (VFL-250) SC-SC Adapter Cord (valid for ST also)	AX203569
Visual Fault Locator (VFL-125) LC-SC/APC Adapter Cord & Support Handle SC/APC Adapter	AX203895
Visual Fault Locator (VFL-250) SC-SC/APC Adapter Cord & Support Handle SC/APC Adapter	AX203930
Fiber/Cable Stripper	AX103151
Pen Marker	AX104279
Refurbishing Materials (80 alcohol wipes and a black pen marker)	AX100951
Safety Glasses	AX104282
Scissors	AX104280
Tweezers	AX104278
Waste Bottle	AX104281



AX104271,
Precision Installation Kit



AX104286,
Precision Cleaver



AX104276, Support Handle
with Adapters

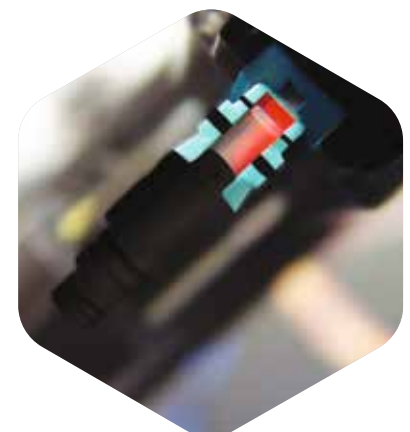

When used with the VFL, a light can be seen through the clear window on the connector body until a fiber has been properly terminated

Ensure Durable Rugged Installation on 250 µm Fiber

Field Breakout kits are available to provide a durable 900 µm coating for 250 µm fibers to ensure optimal retention, flex and twist support without sacrificing the outdoor performance of loose-tube cables or the small diameter of mini-distribution cables.

FX Breakout Kits

Description	Belden Part Number
Breakout Kit for 2.0 mm Subunits, 6-fiber, 1-Pack	AX101100
Breakout Kit for 3.0 mm Subunits, 12-fiber, 1-Pack	AX101101
Breakout kit for 5.2 mm Subunits (Central Tube), 6-fiber, 1-Pack	AX104695
Breakout kit for 5.2 mm Subunits (Central Tube), 12-fiber, 1-Pack	AX104696

i You can use the FX UHD Splice Cassette (see page 20) with the 250 µm Boot to eliminate the need to install a Break-out kit.

COMING
SOON



FiberExpress® Fusion Splice-on Connectors

Belden's FiberExpress (FX) Fusion connectors enable splice-on technology. They combine the benefits of fusion splicing with the simplicity of a field-installable connector to expand your options for field-termination and improve installation performance and reliability over mechanical splice connectors. No crimping, polishing, or adhesives are required for termination, minimizing installation errors.

Benefits

- **Fewer Splice Management Accessories Required**
Eliminates need for splice enclosures and splice trays
- **Flexible Installations**
Run exact length channels to eliminate cable shorts and excess slack
- **Reliable Terminations**
Automated splicing tools consistently provide the highest quality termination
- **Superior Technology and Affordable Quality**
A premium solution without the premium price



Features

- **Fiber Ferrule is Ready for Termination**
Factory pre-cleaved and pre-cleaned fiber stub
- **Better Insertion Loss and Return Loss Performance over Mechanical Splice Connectors**
Superior performance critical to support high-bandwidth/high-speed transmission to applications (25G, 40G and 100G)
- **Robust Connector for Indoor and Outdoor Applications**
Meets TIA-568-D3 and GR-326/1081*
- **Compatible Splicer Accessories**
FX Fusion holders are compatible with industry leading fusion splicers



*GR rating will be available in summer 2017.

Our End-to-End Expertise.
Your End-to-End Solution.



Ordering Information

To use the tailored SmartPart configuration matrices, make a selection from each category and combine to form a custom part number. See example(s) below.

FX Fusion Multimode Connectors

Description	Belden Part Number		
	Multimode, OM1 - Beige	Multimode, OM3/OM4 - Aqua	Multimode, OM4 - Erika Violet
LC with 900 µm Boot, 1/Pack	FT1LC900FS01	FT3LC900FS01	FT4LC900FS01
SC with 900 µm Boot, 1/Pack	FT1SC900FS01	FT3SC900FS01	FT4SC900FS01

FX Fusion Singlemode Connectors

Description	Belden Part Number	
	Singlemode, OS2 - Blue	Singlemode, OS2/APC - Green
LC with 900 µm Boot, 1/Pack	FTSLC900FS01	FTSLB900FS01
SC with 900 µm Boot, 1/Pack	FTSSC900FS01	FTSSB900FS01

FX ECX Splice Cassette Options

Part number example from configuration shown below: **FT3LC900FS01**

FT	3		LC		900		F		S01		
Field Termination	Fiber Type		Connector		Cable Type		Family		Packaging		
1	OM1	LC	LC Simplex		900	Tight Buffer	F	Splice-On		S01	Single Pack
3	OM3	LB	LC/APC Simplex		2MM**	Jacketed					
4	OM4	SC	SC Simplex								
S	OS2	SB	SC/APC Simplex								

FX Fusion Accessories

Description	Belden Part Number
Precision Tool Kit	FXFSTOPTK
Standard Tool Kit	FXFSTOSTK
Precision Cleaver	FXFSTOPCL
Standard Cleaver	FXFSTOSCL
Splice Holder Family 1	FXFSSHFM1*
Splice Holder Family 2	FXFSSHFM2
Slitter for Jacketed Fiber	FXFSTOSLT

*FXFSSHFM1 Holder compatible with Fujikura 60S, Fujikura 70S, Sumitomo Q101, among many others. Visit www.belden.com/splice-on for more details.

FiberExpress Field-Termination FX Fusion Configurator

Part number example from configuration shown below: **FXFSTOSTK**

FX	FS		TO		STK	
FiberExpress	Product Family		Product Type		Other Information	
	FS	FX Fusion	TO	Tools	SPL	Splicer Kit
			SH	Splice Holder	PTK	Precision Tool Kit
					PCL	Precision Cleaver
					SLT	Slitter for Jacketed Fiber
					STK	Standard Tool Kit
					SCL	Standard Cleaver
					FM1	Splice Holder Family 1
					FM2	Splice Holder Family 2

BELDEN

SENDING ALL THE RIGHT SIGNALS



Our End-to-End Expertise.
Your End-to-End Solution.



Wall Mount Systems

Section Table of Contents

■ Wall Mount Systems	
FiberExpress® Wall Mount Systems	62-63
FX UHD Wall Mount	62-63
FX Ultra Wall Mount and Accessories	63-63
FiberExpress® In-Build Systems	64-65
In-Build Wall-Box	64-65



FiberExpress® Wall Mount Systems



AX106818, FX UHD Stackable Wall Mount Patch Panel

FX UHD Wall Mount

Clean, simple, lightweight wall mount unit that accepts all cassettes and frames from the FX UHD ecosystem. The FX UHD wall mount is a modular platform; A vertically stacked configuration creates an interconnect, while the patching spaces can be combined in a horizontal configuration to make a proper cross-connect. There are two separate compartments, one for the main service area (lockable) and one for the patching space. Ideal for MDUs and Passive Optical LAN applications.



AX103928, FX Ultra Stackable Wall Mount Patch Panel

FX Ultra Wall Mount and Accessories

Resolute protection while maintaining the utmost adaptability. Complete selection of fiber enclosures provides effortless security and protection while leveraging both the flexibility and density of the FX UHD frames and cassettes.

Faster

- Faster installation with easy access and lightweight housing
- Faster installation with pre-terminated cassettes

Easier

- Easier configuration with FX UHD and FX Ultra modules in LC, SC and ST
- Easier security with optical door lock
- Easier expansion with stackable design



AX103930, FX Ultra Wall Mount Splice Enclosure

Better

- Better with support for Pre-Term and Field-Term including splicing
- Better management with independent doors for trunk and patching sides
- Better density with up to 36 LC Duplex ports



AX103928 and AX103932,
FX Ultra Wall Mount Patch Panel with Spacer



FX Ultra Splice Trays

Our End-to-End Expertise.
Your End-to-End Solution.



FX UHD Wall Mount

Description	Belden Part Number
FX UHD Wall Mount Patch Panel, Black	AX106817
FX UHD Wall Mount Patch Panel, Gray	AX106818

4 cassettes; 4 frames; 48 fibers (SC, SCD, ST, LCD); 4 FXU Fusion Trays, 8-inch (AX103912)

FX Ultra Wall Mount

Description	Number of Module Bays	Splice Trays	Belden Part Number
Stackable Wall Mount Patch Panel, Black	2	2 x 8" (Up to 48-Splices)	AX103928
Stackable Wall Mount Splice Enclosure	0	4 x 10" (Up to 144-Splices)	AX103930

Splice trays sold separately

FX Ultra Splice Trays

Description	Splices per Tray	Belden Part Number
8" Splice Tray	24	AX103912
10" Splice Tray	36	AX103913

All splice trays accommodate 2.5 mm OD single fiber splice protectors up to 80 mm in length or part number FXFUHS900AB25

FX Ultra Wall Mount Accessories

Description	Belden Part Number
2-inch Spacer, Black	AX103932
Door Lock Kit	AX103934

FiberExpress® In-Build Systems

In-Build Wall-Box

- Data module of hybrid cabinets for home distribution systems. IP20 / IK05
- Welded frame from 1 mm thick sheet steel combined with plastic PEHD 8 mm
- Frame door combined with steel of 1 mm thickness and plastic PP-H 1,5 mm
- Designed enabling WiFi supported devices
- Hybrid key-connect design with Keystone CAT5e/6/6A Jacks, OFC Keystone SC/APC – DX LC/APC adapters and Other Keystone multi-media connectivity



Our End-to-End Expertise.
Your End-to-End Solution.



Ordering Information

For empty box, the part numbers are:

EWFL-FTTX-L	Large Empty Wall-Box (H1100xW396xD131mm)
EWFM-FTTX-M	Medium Empty Wall-Box (H500 x W500 x D110mm)

For wall box loaded with jacks and/or adapters and pigtails, please use the configurator below:

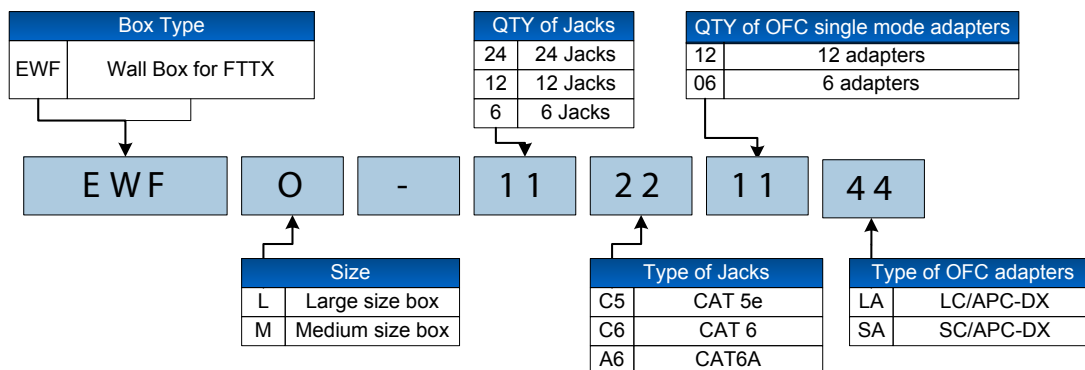

Example:

EWFL-24C606LA	Large FTTx box with 24 CAT6 + 6 LC/APC and splice tray
EWFM-24C606LA	Medium FTTx box with 24 CAT6 + 6 LC/APC and splice tray



BELDEN
SENDING ALL THE RIGHT SIGNALS



Our End-to-End Expertise.
Your End-to-End Solution.



Optical Fiber Cables

Section Table of Contents

Optical Fiber Cables	
Belden Optical Fiber Cables	68
Fiber Types	69
Universal Central Loose Tube Cable with Rodent Protection, Single Jacket	70-71
Universal Mini-Breakout	72-73
Belden Warranties and Certification	74-75

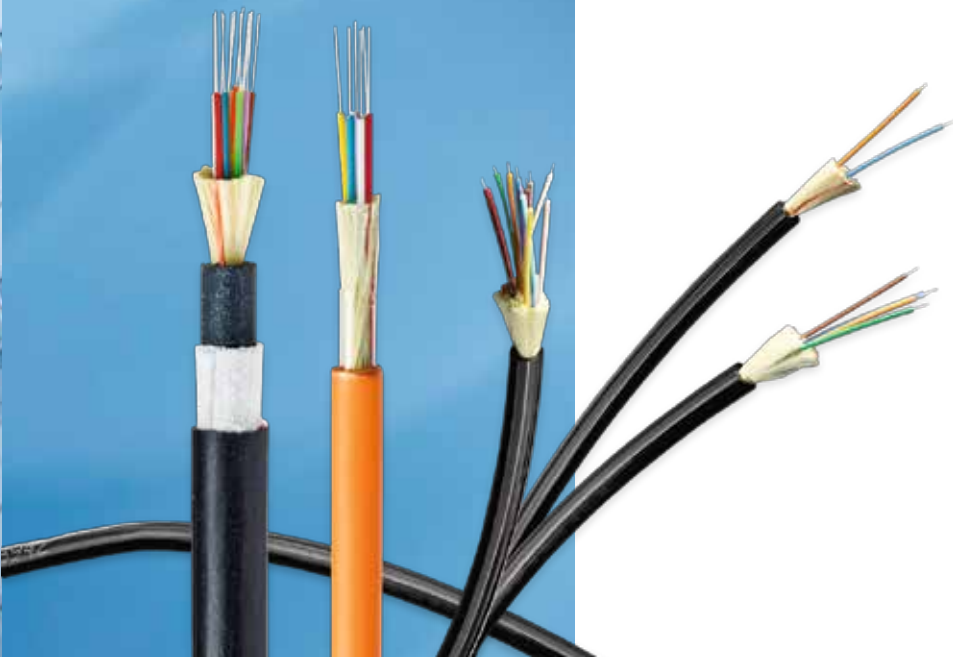

Belden Optical Fiber Cables

Reduce Complexity and Increase Flexibility

Today's advanced networks are diverse and almost always complex. The right way ahead is to future-proof these networks and to take precautions to protect them against anything that will create problems, damage or disruption. That means matching the right hardware with the right cabling to guarantee performance – and that means choosing fiber optic cable. Optical fiber cables offer many benefits: high bandwidth and transmission speed, the potential for network growth, extended reach, fault tolerance, greater data security and support for Gigabit and multi-Gigabit protocols and networked applications.

Involved in the development of optical fiber components for over 40 years, Belden is a leading supplier of high-quality, cost-effective optical fiber cabling systems. Belden's fiber cabling range is the culmination of our experience and expertise in a variety of applications, including data centers, premise and campus network backbone infrastructures, fiber-to-the-desk (FTTD) applications, horizontal and centralized cabling systems. Belden's fiber cables are designed to offer reduced complexity, increased flexibility, and rapid installation for maximum cost effectiveness.

This catalog will provide you with comprehensive information about our optical fiber cabling portfolio – from buffered fiber cables right through to central and multi loose tube variations for several applications. The upcoming pages contain all the key technical data and ordering information about the products to help you with configuring the right fiber backbone for your next mission critical application.

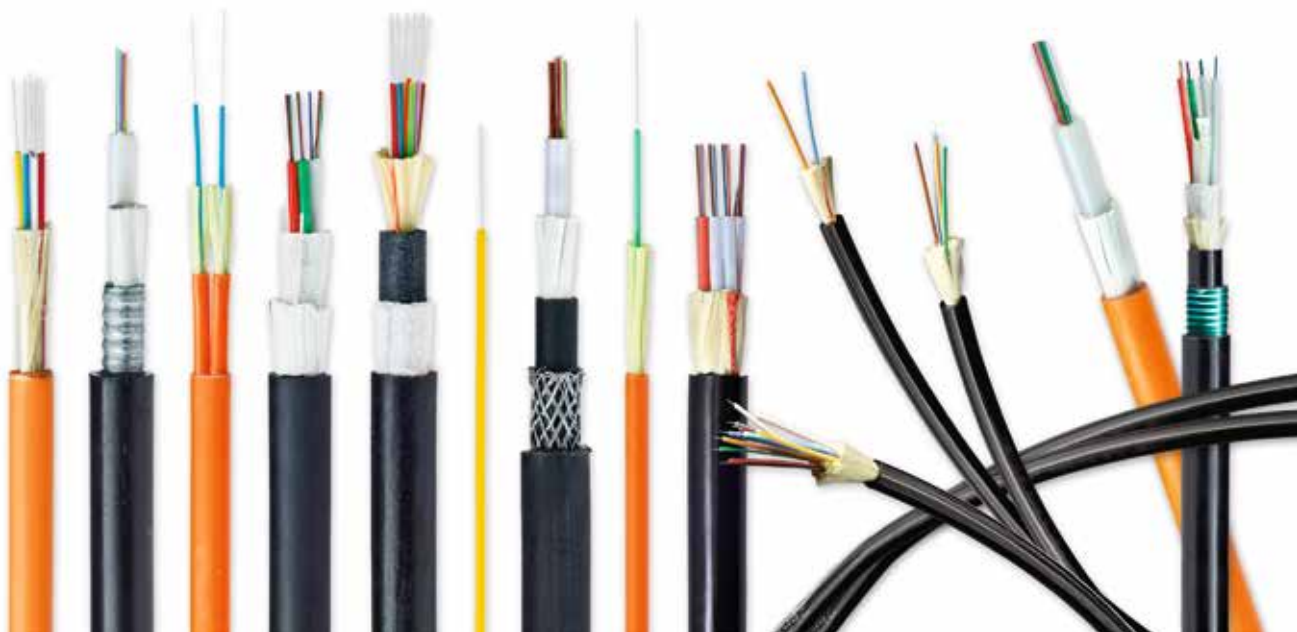

Our End-to-End Expertise.
Your End-to-End Solution.



Fiber Types

Tight Buffer Optical Characteristics

European Part Number Coding, Position 5	Fiber-Type	Mode-Field/Cladding Diameter (μm)	Wave-length (nm)	Attenuation Average/max. (dB/km)	Dispersion (ps/nm-km)	PMD (ps/km)	Cable Cut-off Wave-length (nm)	Min. Bending Radius (mm)
---	------------	-----------------------------------	------------------	----------------------------------	-----------------------	-------------	--------------------------------	--------------------------

Characteristics (cabled) Single-Mode • Matched-Cladded Optical Fibers according to ITU

A	9/125	8.9 ± 0.4	1310	0.35/0.4	≤ 3.5	≤ 0.2 ^A	≤ 1260	10
	G.657A1 OS2	125.0 ± 0.3	1550 1625	0.21/0.3 0.24/0.4	≤ 18.0			
F	9/125	8.9 ± 0.4	1310	0.35/0.4	≤ 3.5	≤ 0.2 ^A	≤ 1260	7.5
	G.657A2 OS2	125.0 ± 0.3	1550 1625	0.21/0.3 0.24/0.4	≤ 18.0			
I	9/125	8.8 ± 0.4	1310	0.35/0.4	≤ 3.5	≤ 0.2 ^A	≤ 1260	5.0
	G.657B3 OS2	125.0 ± 0.3	1550 1625	0.22/0.3 0.24/0.4	≤ 18.0			

European Part Number Coding, Position 5	Fiber-Type	Core/Cladding Diameter (μm)	Wave-length (nm)	Attenuation Average/max. (dB/km)	Bandwidth (MHz/km)	Ethernet Performance (m)		Num. Apert. (μm)	Min. Bending Radius (mm)
						1 GBE	10 GBE		

Characteristics (cabled) Multi-Mode • Graded-Index Optical Fibers according to IEC 60793

1	62.5/125 OM1	62.5 ± 2.5	850	2.7/3.2	≥ 200	275	33	0.275 ± 0.015	25
		125.0 ± 1.0	1300	0.6/1.1	≥ 600	550	300		
2	50/125 OM2	50.0 ± 2.5	850	2.4/3.0	≥ 500	600	82	0.200 ± 0.015	25
		125.0 ± 1.0	1300	0.7/1.0	≥ 500	600	300		
3	50/125 OM3	50.0 ± 2.5	850	2.5/3.0	≥ 1500	900	300	0.200 ± 0.015	25
		125.0 ± 1.0	1300	0.5/1.0	≥ 500	550	300		
D	50/125 OM3 Flex	50.0 ± 2.5	850	2.5/3.0	≥ 1500	900	300	0.200 ± 0.015	7.5
		125.0 ± 1.0	1300	0.5/1.0	≥ 500	550	300		
6	50/125 OM4	50.0 ± 2.5	850	2.5/3.0	≥ 6000	900	550	0.200 ± 0.015	25
		125.0 ± 1.0	1300	0.5/1.0	≥ 500	550	300		
E	50/125 OM4 Flex	50.0 ± 2.5	850	2.5/3.0	≥ 6000	900	550	0.200 ± 0.015	7.5
		125.0 ± 1.0	1300	0.5/1.0	≥ 500	550	300		

Loose Tube Optical Characteristics

European Part Number Coding, Position 5	Fiber-Type	Mode-Field/Cladding Diameter (μm)	Wave-length (nm)	Attenuation average/max. (dB/km)	Dispersion (ps/nm-km)	PMD (ps/km)	Cable Cut-off Wave-length (nm)
---	------------	-----------------------------------	------------------	----------------------------------	-----------------------	-------------	--------------------------------

Characteristics (cabled) Single-Mode • Matched-Cladded Optical Fibers according to ITU

8	9/125	9.2 ± 0.4	1310	0.32/0.40	≤ 3.5	≤ 0.2 ^A	≤ 1260
	G.652D OS2	125.0 ± 0.7	1550	0.19/0.22	≤ 18.0		
7	9/125	8.4 ± 0.6	1550	0.25/0.30	3.5 – 8.5	≤ 0.1 ^A	≤ 1260
	G.655 C & D	125.0 ± 1.0					

European Part Number Coding, Position 5	Fiber-Type	Core/Cladding Diameter (μm)	Wave-length (nm)	Attenuation average/max. (dB/km)	Bandwidth (MHz/km)	Ethernet Performance (m)		Num. Apert. (μm)	Num. Apert. (μm)
						1 GBE	10 GBE		

Characteristics (cabled) Multi-Mode • Graded-Index Optical Fibers according to IEC 60793

1	62.5/125 OM1	62.5 ± 2.5	850	2.7/3.2	≥ 200	275	33	0.275 ± 0.015	1.495
		125.0 ± 1.0	1300	0.6/1.1	≥ 600	550	300		1.490
2	50/125 OM2	50.0 ± 2.5	850	2.4/3.0	≥ 500	600	82	0.200 ± 0.015	1.481
		125.0 ± 1.0	1300	0.7/1.0	≥ 500	600	300		1.476
3	50/125 OM3	50.0 ± 2.5	850	2.5/3.0	≥ 1500	900	300	0.200 ± 0.015	1.482
		125.0 ± 1.0	1300	0.5/1.0	≥ 500	550	300		1.477
6	50/125 OM4	50.0 ± 2.5	850	2.5/3.0	≥ 6000	900	550	0.200 ± 0.015	1.482
		125.0 ± 1.0	1300	0.5/1.0	≥ 500	550	300		1.477

Note A: Link design value



Universal Central Loose Tube Cable with Rodent Protection, Single Jacket

GUSN, GUSL, GURN, GUVN

A/I-DQ(ZN)BH



Applications

- For outdoor and indoor use in structured (data) wiring systems such as campus backbone
- Easy to install in ducts, tunnels and trenches by means of compressed air or pulling wire
- Suitable for direct burial

Features & Benefits

- Available in sizes from 2 to 24 fibers
- Jelly filled (non-dripping and silicon-free) loose tube with primary coated optical fibers ($\varnothing 250 \pm 15 \mu\text{m}$)
- Full dielectric construction, no grounding required
- Rodent protected by means of Glass Yarn Strength Elements
- Length marking in meters for easy determination of the cable length

Cross Section

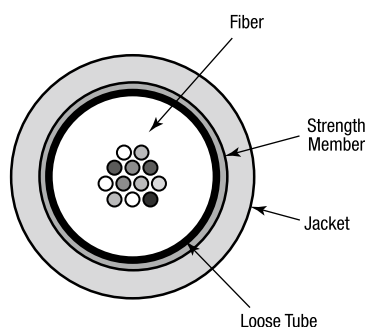

Specifications

IEC 60794-1-2	
Crush Resistance (E3):	15 kN/m
Min. Bend Radius dynamic (E6):	15 x \varnothing
Min. Bend Radius static (E11):	10 x \varnothing
Min. Bend Radius fibers:	25 mm
Temperature Range (F1):	
– Transport/Storage	-30°C to +70°C
– Installation	-5°C to +50°C
– Operation	-30°C to +70°C
Watertightness (F5):	Pass
Other	
Flame Retardant:	
– GUSN, GURN, GUVN	IEC 60332-1
– GUSL	IEC 60332-3-25
Halogen Free:	IEC 60754-1
Non Corrosive:	IEC 60754-2
Smoke Density:	IEC 61034-2

Our End-to-End Expertise.
Your End-to-End Solution.



Characteristics

Loose Tube	Fiber Count	Diameter (mm)	Weight (kg/km)	Tensile Strength (short term) N	Tensile Strength (permanent) N	Fire Load (kJ/m)
IEC 60794-1-2				E1	E1	
GUSN*xx	2 to 24	5.8	37	1500	700	550
GUSL*xx	2 to 24	6.5	47	1500	700	580
GURN*xx	2 to 24	7.1	55	3500	1750	755
GUVN*xx	2 to 24	7.8	67	5000	2500	928

Ordering Information

Fiber Type/Count	2	4	6	8	12	16	24
GUSN							
62.5/125-OM1	GUSN102	GUSN104	GUSN106	GUSN108	GUSN112	GUSN116	GUSN124
50/125-OM2	GUSN202	GUSN204	GUSN206	GUSN208	GUSN212	GUSN216	GUSN224
50/125-OM3	GUSN302	GUSN304	GUSN306	GUSN308	GUSN312	GUSN316	GUSN324
50/125-OM4	GUSN602	GUSN604	GUSN606	GUSN608	GUSN612	GUSN616	GUSN624
9/125 ITU G.652D	GUSN802	GUSN804	GUSN806	GUSN808	GUSN812	GUSN816	GUSN824
9/125 ITU G.655 C & D	GUSN702	GUSN704	GUSN706	GUSN708	GUSN712	GUSN716	GUSN724
GUSL							
62.5/125-OM1	GUSL102	GUSL104	GUSL106	GUSL108	GUSL112	GUSL116	GUSL124
50/125-OM2	GUSL202	GUSL204	GUSL206	GUSL208	GUSL212	GUSL216	GUSL224
50/125-OM3	GUSL302	GUSL304	GUSL306	GUSL308	GUSL312	GUSL316	GUSL324
50/125-OM4	GUSL602	GUSL604	GUSL606	GUSL608	GUSL612	GUSL616	GUSL624
9/125 ITU G.652D	GUSL802	GUSL804	GUSL806	GUSL808	GUSL812	GUSL816	GUSL824
9/125 ITU G.655 C & D	GUSL702	GUSL704	GUSL706	GUSL708	GUSL712	GUSL716	GUSL724
GURN							
62.5/125-OM1	GURN102	GURN104	GURN106	GURN108	GURN112	GURN116	GURN124
50/125-OM2	GURN202	GURN204	GURN206	GURN208	GURN212	GURN216	GURN224
50/125-OM3	GURN302	GURN304	GURN306	GURN308	GURN312	GURN316	GURN324
50/125-OM4	GURN602	GURN604	GURN606	GURN608	GURN612	GURN616	GURN624
9/125 ITU G.652D	GURN802	GURN804	GURN806	GURN808	GURN812	GURN816	GURN824
9/125 ITU G.655 C & D	GURN702	GURN704	GURN706	GURN708	GURN712	GURN716	GURN724
GUVN							
62.5/125-OM1	GUVN102	GUVN104	GUVN106	GUVN108	GUVN112	GUVN116	GUVN124
50/125-OM2	GUVN202	GUVN204	GUVN206	GUVN208	GUVN212	GUVN216	GUVN224
50/125-OM3	GUVN302	GUVN304	GUVN306	GUVN308	GUVN312	GUVN316	GUVN324
50/125-OM4	GUVN602	GUVN604	GUVN606	GUVN608	GUVN612	GUVN616	GUVN624
9/125 ITU G.652D	GUVN802	GUVN804	GUVN806	GUVN808	GUVN812	GUVN816	GUVN824
9/125 ITU G.655 C & D	GUVN702	GUVN704	GUVN706	GUVN708	GUVN712	GUVN716	GUVN724
GUSN • GURN • GUVN							
Std. plywood reel (non-returnable)				Ø 800 x 475 mm, Weight 7.65 kg and Ø 1000 x 530 mm, Weight 18.0 kg			
Std. delivery length				2100 ± 100 m and 4100 ± 100 m			

Fiber Color Coding

No.		No.		No.		No.		No.		No.	
1	Red	5	Green	9	Orange	13	Red + ring	17	Green + ring	21	Orange + ring
2	Natural	6	Violet	10	Turquoise	14	Natural + ring	18	Violet + ring	22	Turquoise + ring
3	Yellow	7	Brown	11	Pink	15	Yellow + ring	19	Brown + ring	23	Pink + ring
4	Blue	8	Black	12	White	16	Blue + ring	20	Grey + ring	24	White + ring



Universal Mini-Breakout

**GUMT
GUMS**

**A/I-V(ZN)H
A/I-K(ZN)H**



Applications

- Structured (premises) wiring systems: campus and/or building backbone (riser) and/or horizontal cabling
- Support all computer network applications such as FDDI, Gigabit Ethernet and ATM
- Easy to install in ducts, tunnels and trenches. Not recommended for direct burial

Features & Benefits

- Available in sizes from 2 to 72 fibers
- 900 µm buffered fiber allows for use of field-installable connectors
- Semi-tight buffered optical fibers are easily strippable
- Length marking in meters for easy determination of the cable length
- Full dielectric construction, no grounding required
- These cables are halogen-free (= FRNC and LSNH) and watertight and therefore suitable for internal and external use. Consequently splicing can be avoided and the installation gets more cost-effective.

Cross Section

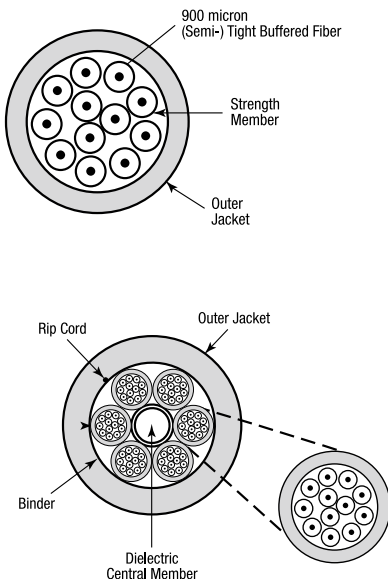

Specifications

IEC 60794-1-2	
Crush Resistance (E3):	4 kN/m
Min. Bend Radius dynamic (E6):	20 x Ø
Min. Bend Radius static (E11):	15 x Ø
Min. Bend Radius fibers:	25 mm
Temperature Range (F1):	
– Transport/Storage	-30°C to +70°C
– Installation	-5°C to +50°C
– Operation	-30°C to +70°C
Watertightness (F5):	Pass
Stripping (E5), Semi-Tight:	
– Secondary coating	> 30 cm
– Primary and Secondary	> 10 mm
Stripping (E5), Tight:	
– Secondary coating	> 10 cm
– Primary and Secondary	> 10 mm
Other	
Flame Retardant:	IEC 60332-3-24
Halogen Free:	IEC 60754-1
Non Corrosive:	IEC 60754-2
Smoke Density:	IEC 61034-2

Our End-to-End Expertise.
Your End-to-End Solution.



Characteristics

Tight Buffer	Semi-Tight Buffer	Fiber Count	Diameter (mm)	Weight (kg/km)	Tensile Strength (short term) N	Tensile Strength (permanent) N	Fire Load (kJ/m)
GUMT*02	GUMS*02	1 x 2	5.4	26	800	400	296
GUMT*04	GUMS*04	1 x 4	5.4	26	800	400	296
GUMT*06	GUMS*06	1 x 6	5.9	30	900	450	347
GUMT*08	GUMS*08	1 x 8	5.9	32	900	450	371
GUMT*12	GUMS*12	1 x 12	7.6	45	1000	500	622
GUMT*16	GUMS*16	1 x 16	8.6	53	1000	500	845
GUMT*24	GUMS*24	1 x 24	9.6	74	1200	600	1082
GUMT*36	GUMS*36	3 x 12	19.7	246	5400	2700	2345
GUMT*48	GUMS*48	4 x 12	19.7	286	5400	2700	2970
GUMT*72	GUMS*72	6 x 12	24.6	438	6000	3000	4290

Note: Buffer diameter 0.90 ± 0.05 mm

Ordering Information

Fiber Type/Count	2	4	6	8	12	16	24	36	48	72	Jacket Color	
GUMT • Tight Buffer												
62.5/125-OM1	GUMT102	GUMT104	GUMT106	GUMT108	GUMT112	GUMT116	GUMT124	GUMT136	GUMT148	GUMT172	Orange	
50/125-OM2	GUMT202	GUMT204	GUMT206	GUMT208	GUMT212	GUMT216	GUMT224	GUMT236	GUMT248	GUMT272	Orange	
50/125-OM3	GUMT302	GUMT304	GUMT306	GUMT308	GUMT312	GUMT316	GUMT324	GUMT336	GUMT348	GUMT372	Aqua	
50/125-OM3 Flex	GUMTD02	GUMTD04	GUMTD06	GUMTD08	GUMTD12	GUMTD16	GUMTD24	GUMTD36	GUMTD48	GUMTD72	Aqua	
50/125-OM4	GUMT602	GUMT604	GUMT606	GUMT608	GUMT612	GUMT616	GUMT624	GUMT636	GUMT648	GUMT672	Erika-Violet (RAL 4003)	
50/125-OM4 Flex	GUMTE02	GUMTE04	GUMTE06	GUMTE08	GUMTE12	GUMTE16	GUMTE24	GUMTE36	GUMTE48	GUMTE72	Erika-Violet (RAL 4003)	
9/125 ITU G.657A1	GUMTA02	GUMTA04	GUMTA06	GUMTA08	GUMTA12	GUMTA16	GUMTA24	GUMTA36	GUMTA48	GUMTA72	Yellow	
9/125 ITU G.657A2	GUMTF02	GUMTF04	GUMTF06	GUMTF08	GUMTF12	GUMTF16	GUMTF24	GUMTF36	GUMTF48	GUMTF72	Yellow	
9/125 ITU G.657B3	GUMTI02	GUMTI04	GUMTI06	GUMTI08	GUMTI12	GUMTI16	GUMTI24	GUMTI36	GUMTI48	GUMTI72	Yellow	
GUMS • Semi-Tight Buffer												
62.5/125-OM1	GUMS102	GUMS104	GUMS106	GUMS108	GUMS112	GUMS116	GUMS124	GUMS136	GUMS148	GUMS172	Orange	
50/125-OM2	GUMS202	GUMS204	GUMS206	GUMS208	GUMS212	GUMS216	GUMS224	GUMS236	GUMS248	GUMS272	Orange	
50/125-OM3	GUMS302	GUMS304	GUMS306	GUMS308	GUMS312	GUMS316	GUMS324	GUMS336	GUMS348	GUMS372	Aqua	
50/125-OM3 Flex	GUMSD02	GUMSD04	GUMSD06	GUMSD08	GUMSD12	GUMSD16	GUMSD24	GUMSD36	GUMSD48	GUMSD72	Aqua	
50/125-OM4	GUMS602	GUMS604	GUMS606	GUMS608	GUMS612	GUMS616	GUMS624	GUMS636	GUMS648	GUMS672	Erika-Violet (RAL 4003)	
50/125-OM4 Flex	GUMSE02	GUMSE04	GUMSE06	GUMSE08	GUMSE12	GUMSE16	GUMSE24	GUMSE36	GUMSE48	GUMSE72	Erika-Violet (RAL 4003)	
9/125 ITU G.657A1	GUMSA02	GUMSA04	GUMSA06	GUMSA08	GUMSA12	GUMSA16	GUMSA24	GUMSA36	GUMSA48	GUMSA72	Yellow	
9/125 ITU G.657A2	GUMSF02	GUMSF04	GUMSF06	GUMSF08	GUMSF12	GUMSF16	GUMSF24	GUMSF36	GUMSF48	GUMSF72	Yellow	
9/125 ITU G.657B3	GUMSI02	GUMSI04	GUMSI06	GUMSI08	GUMSI12	GUMSI16	GUMSI24	GUMSI36	GUMSI48	GUMSI72	Yellow	
GUMT • GUMS												
Std. plywood reel (non-returnable)	Ø 560 x 336 mm, Weight 4.25 kg	Ø 800 x 475 mm, Weight 7.65 kg	Ø 1000 x 530 mm, Weight 18.0 kg	Ø 1000 x 530 mm, Weight 18.0 kg	Ø 1250 x 688mm, Weight 93.0 kg							-
Std. delivery length	2100 ± 100 m	2100 ± 100 m	2100 ± 100 m	650 ± 100 m	650 ± 100 m							-

Fiber Color Coding

No.		No.		No.		No.		No.		No.	
1	White	5	Green	9	Orange	13	White + ring	17	Green + ring	21	Orange + ring
2	Red	6	Violet	10	Turquoise	14	Red + ring	18	Violet + ring	22	Turquoise + ring
3	Blue	7	Brown	11	Pink	15	Blue + ring	19	Brown + ring	23	Pink + ring
4	Yellow	8	Black	12	Grey	16	Yellow + ring	20	Black + ring	24	Grey + ring

Performance & Warranties Profile *for* Belden IBDN FiberExpress Certified System Installations

Belden will provide its authorized Certified System Vendors (CSVs), for the benefit of their end users, with both an extended Belden IBDN Component Warranty and a lifetime Application Assurance Program for all Belden IBDN FiberExpress Certified Systems installed by the CSV.

The extended Belden IBDN Component Warranty and the lifetime Application Assurance Program are offered to the CSV by Belden, in accordance with the following terms and conditions.

This Warranty and this Assurance Program apply only to Belden IBDN FiberExpress Certified Systems installed by CSV acting as an authorized Certified System Vendor (CSV) and in compliance with the CSV Agreement.

A Belden IBDN FiberExpress Certified System is a structured cabling system that has been engineered, designed and installed by the CSV acting as an authorized Belden CSV. The engineering, design and installation of the Belden IBDN System must be performed in accordance with all applicable Belden IBDN guidelines, Belden IBDN practices, and other Belden IBDN documentation in effect at the time of installation. Belden IBDN FiberExpress System installations that meet these requirements will receive a Certification Registration Number and Certification Plaque or Certificate from Belden and will then be designated as a Belden IBDN FiberExpress Certified System, eligible for the extended Belden IBDN Component Warranty and lifetime Application Assurance Program described below.

In order to maintain the validity of the extended Belden IBDN Component Warranty and the lifetime Application Assurance Program, the Belden IBDN FiberExpress Certified System must be maintained in accordance with the Belden IBDN User Manual in effect at the time of installation.

Extended Belden IBDN Component Warranty:

Belden warrants that;

i) the Belden IBDN passive components installed in the Belden IBDN FiberExpress Certified System are covered by a manufacturer's warranty against defects in material and workmanship for a period of twenty-five (25) years from the date of installation, at the original installation location.

ii) the Belden IBDN FiberExpress Certified System will meet or exceed the requirements specified by:

ANSI/TIA/EIA-568-B.1: Commercial Building Telecommunications Cabling Standard, Part 1: General Requirements

ANSI/TIA/EIA-568-B.3: Commercial Building Telecommunications Cabling Standard, Part 3: Optical Fiber Cabling

ANSI/TIA/EIA-568-B.3-1: Addendum 1 - Additional Transmission Performance Specifications for 50/125 μm Optical Fiber Cables

Once an installed Belden IBDN passive component has been deemed defective by Belden, Belden shall repair or replace, at Belden's discretion, the defective component. The repaired or replaced component will be warranted for the balance of the original twenty-five year warranty period, or, ninety (90) days, which ever is longer.

The repair or replacement of a defective component under this warranty includes the reasonable costs of labor required to repair or replace the defective component. The decision of repair or replacement of components, and the selection of labor services to perform the repair or replacement are at the sole discretion of Belden.

Application Assurance:

In addition to the extended Belden IBDN Component Warranty, Belden also provides a lifetime Application Assurance Program for all Belden IBDN FiberExpress Certified Systems.

Belden lifetime Application Assurance Program warrants that the Belden IBDN FiberExpress Certified System, maintained in accordance with the Belden IBDN User Guide in effect and provided at the time of installation, will be capable of supporting all industry standard Applications during its entire installation life at its original installation location.

Industry standard Applications include;

- i) all Applications identified in the current (at time of installation) Belden IBDN documentation, and;
- ii) any commercially available Applications introduced at a future date that are designed to operate over ANSI/TIA/EIA-568-B.3 and ANSI/TIA/EIA-568-B.3-1 compliant optical fiber transmission channels.

In the event that the Belden IBDN FiberExpress Certified System is unable to support an existing or future industry standard Application as defined above, and such failure can be attributed to a deficiency in the Belden IBDN System, Belden will provide at its expense, reasonable expertise, Belden IBDN materials and labor as required to remedy the problem and/or resolve the claim. The decision of repair or replacement of materials, and the selection of labor services to perform the remedial services are at the sole discretion of Belden.

Limitations

Belden will not be liable for, nor pay for, any loss of use of the Belden IBDN System or products; costs of substitute goods, facilities or services; or for any other economic losses or incidental, consequential or exemplary damages.

This Extended Product Warranty and Application Assurance for the Belden IBDN Certified System does not cover any deficiencies in the System which result from failure to comply with Belden design guidelines and installation procedures.

Belden shall not be liable for damages or defects resulting from circumstances beyond its control, including but not limited to, improper installation, misuse, alteration, unauthorized repair, damages in transit, fire, floods and acts of God.

Repair or replacement of the Belden IBDN Certified System by Belden is your exclusive remedy.

This is the only warranty on the Belden IBDN FiberExpress Certified System. There are no other warranties, express or implied, made by Belden.

Our End-to-End Expertise.
Your End-to-End Solution.



Belden IBDN Structured Cabling Systems • Belden IBDN FiberExpress Certified System Installations

Belden IBDN FiberExpress Cabling Solution

In addition to the extended Belden IBDN Component Warranty, the lifetime Application Assurance Program and full compliance with ANSI/TIA/EIA-568-B Standards, Belden IBDN FiberExpress Certified Systems that conform with the Belden IBDN FiberExpress Certified System channel configuration shown below are guaranteed to provide the following optical performance

characteristics for the duration of their installed lifetime at the original site of installation. All conditions regarding original design, installation and maintenance for Belden IBDN FiberExpress Certified Systems must be met in order to validate these optical performance characteristics.

Belden IBDN FiberExpress System		Max. Channel Attenuation (2 mated pair connector topology)		Max. Supportable Distance	
		850 nm	1300 nm	850 nm	1300 nm
FiberExpress 300 ⁽¹⁾	62.5 μm multimode	3.2 dB	4.0 dB	300 m (985 ft)	550 m (1805 ft)
FiberExpress 600 ⁽¹⁾	50 μm multimode	3.9 dB	3.5 dB	600 m (1970 ft)	600 m (1970 ft)
FiberExpress 2000 ⁽²⁾	50 μm multimode	2.6 dB	—	300 m (985 ft)	—
Singlemode ⁽³⁾	Loose tube optical fiber cable	—	4.7 dB	—	5000 m (16,405 ft)

1) Budget and length limitations shown are for 1 Gb/s applications including 1000Base-SX and 1000Base-LX Gigabit Ethernet. Maximum channel attenuation and maximum channel length limitations for other applications are specified in the Belden IBDN Optical Fiber Design in effect at the time of installation.

2) Budget and length limitations shown are for 10 Gb/s applications including 10Base-S Ethernet. If 10GBase-LX4 is used, the maximum channel attenuation is 2.0 dB and the maximum channel length is 300 m (985 ft). Maximum channel attenuation and maximum channel length limitations for other applications are specified in the Belden IBDN Optical Fiber Design in effect at the time of installation.

3) Singlemode tight buffer optical fiber cable is available; Budget and length limitations shown are for 1 Gb/s including 1000Base-LX Gigabit Ethernet. Maximum channel attenuation and maximum channel length limitations for other applications are specified in the Belden IBDN Optical Fiber Design Guide in effect at the time of installation.

Belden IBDN FiberExpress System Channel Backbone Configuration



* 2 mated pair connector channel topology

Belden IBDN FiberExpress System Channel Centralized / Horizontal Configuration



* 2 mated pair connector channel topology

Belden IBDN FiberExpress System Matrix	Fiber Channel Topology			
	Fiber-to-the-Desk (FTTD) & Centralized Fiber	Fiber Backbone (In-Building)	Fiber Backbone (Campus)	FiberExpress Pre-terminated Solutions*
FiberExpress Cables				
Breakout & Distribution Cable Series: MM & SM	✓	✓		
Interconnect Cable Series: MM & SM	✓			
Loose Tube (Campus) Cable Series: MM & SM, Composite MM/SM		✓	✓	
FiberExpress Ribbon Cable Series: MM & SM	✓	✓	✓	✓
Cross-Connect Hardware in the Telecommunications Room				
FiberExpress Manager with FiberExpress Manager Connector Modules: MM & SM	✓	✓	✓	✓
FiberExpress Rack Mount Patch Panel with Universal Adapter Strips: MM & SM	✓	✓	✓	
FiberExpress Wall Mount Patch Panel with Universal Adapter Strips: MM & SM	✓	✓	✓	
FiberExpress Bar: MM & SM	✓	✓	✓	✓
Patch Cords in the Telecommunications Room and at the Work Area				
FiberExpress Patch Cords: MM & SM	✓	✓	✓	✓
Outlets at the Work Area				
MDVO Multimedia Outlets with MDVO Multimedia Modules	✓			
MediaFlex Outlets with MediaFlex Inserts	✓			
FiberExpress Bar: MM & SM (as MUTOA)	✓			✓
Fiber Connectivity				
Optimax Connectors: MM & SM	✓	✓	✓	
Epoxy Field Mountable Connectors: MM & SM	✓	✓	✓	
Fiber Pigtailed: MM & SM	✓	✓	✓	

MM = Multimode SM = Singlemode

* FiberExpress Pre-terminated solutions provide simple-to-install, high performance fiber channels through custom length, high precision factory terminated cables and matching optical connectivity components.

BELDEN
SENDING ALL THE RIGHT SIGNALS®

GLOBAL LOCATIONS

For more information, please visit us at:
www.beldensolutions.com



**Be certain
you stay
in touch.**

EUROPE/MIDDLE EAST/AFRICA

Germany

Phone: +49-7127-14-0
venlo.salesinfo@belden.com

France

Phone: +33-472-109-990
lyon.salesinfo@belden.com

Italy

Phone: +39-039-5965-250
info.milano@belden.com

Russia

Phone: +7-495-787-06-55
info@belden.ru

Spain

Phone: +34-91-746-17-30
madrid.salesinfo@belden.com

Sweden

Phone: +46-40-699-88-60
venlo.salesinfo@belden.com

The Netherlands

Phone: +31-773-878-555
venlo.salesinfo@belden.com

United Arab Emirates

Phone: +971-4-391-0490
dubai.salesinfo@belden.com

United Kingdom

Phone: +44-161-49837-49
manchester.salesinfo@belden.com

AMERICAS

USA

Phone: +1-800-BELDEN1
(1-800-235-3361)

ASIA/PACIFIC

Singapore

Phone: +65-6879-9800
apac.ecsmarketing@belden.com

China

Phone: +86-21-5445-2388
apac.ecsmarketing@belden.com

IBDN is a registered trademark of Nordx/CDT which was acquired by Belden on February 2, 1996. Belden, Belden Sending All The Right Signals, GarrettCom, Hirschmann, Lumberg Automation, Tofino Security, Tripwire and the Belden logo are trademarks or registered trademarks of Belden Inc. or its affiliated companies in the United States and other jurisdictions. Belden and other parties may also have trademark rights in other terms used herein.